

# PRK-1UM

---



---

IT

IL DISPOSITIVO DELLO SVILUPPO DELLE  
CONCENTRAZIONI DELLA VITA ETERNA PRK-1UM  
MODIFICATO A TRE MODALITÀ

Descrizione e metodi di lavoro con il dispositivo



# **Il dispositivo dello sviluppo delle concentrazioni della vita eterna PRK-1UM modificato a tre modalità**

## **Descrizione e metodi di lavoro con il dispositivo**

### **Contenuto**

• Avvertenza prima dell'utilizzo del dispositivo PRK-1UM.....	3
• Istruzioni per l'accensione del dispositivo PRK-1UM.....	4
• Funzionamento del dispositivo PRK-1UM in modalità di utilizzo della scheda SD.....	12
• Descrizione del dispositivo dello sviluppo delle concentrazioni della vita eterna PRK-1UM modificato a tre modalità.....	13
• Informazioni su certificati, brevetti e marchi .....	16
• Prova di operatività del dispositivo PRK-1U .....	17
• Risultati dell'uso del dispositivo dello sviluppo delle concentrazioni della vita eterna PRK-1U .....	18
• Metodologie di lavoro con il dispositivo dello sviluppo delle concentrazioni della vita eterna PRK-1U.....	18
• Giustificazione del prezzo dell'accordo di Sublicenza per il Programma Educativo con PRK-1UM.....	20
• Modulo dell'accordo di agenzia per il diritto di organizzare accordi di Sublicenza per il Programma Educativo con PRK-1UM.....	22
• Fotocopie del brevetto "Metodo di prevenzione delle catastrofi e dispositivo per la sua realizzazione "e del brevetto" Sistema di trasporto delle informazioni" .....	26
• Brevetto "Il dispositivo dello sviluppo delle concentrazioni della vita eterna PRK-1U a tre modalità" .....	28
• Certificati di registrazione della progettazione industriale del dispositivo PRK-1UM .....	49
• In Gran Bretagna (Intellectual Property Office) .....	49
• In Belgio, Paesi Bassi, Lussemburgo (Benelux (BOIP)) .....	53
• In Svizzera (Istituto Federale della Proprietà Intellettuale).....	54
• In Germania (Deutsches Patent- und Markenamt) .....	57
• In Giappone (Japan Patent Office) .....	62
• Fotocopie dei marchi .....	68
• Certificato dei "Laboratori Idvorsky" di conformità del dispositivo PRK-1UM alle Norme sulla compatibilità elettromagnetica .....	77
• Relazione aggiuntiva di "Idvorski Laboratorije" sul test del dispositivo PRK-1UM con un laser di classe 1 .....	79

---

Sulla base e in conformità con il brevetto di Grigori Grabovoi "Metodo di prevenzione delle catastrofi e dispositivo per la sua realizzazione" e con le altre sue invenzioni, in cui viene eseguita la normalizzazione di un impulso di controllo, Grigori Grabovoi ha creato il dispositivo dello sviluppo delle concentrazioni della vita eterna PRK-1UM a tre modalità.

Il dispositivo è basato sul principio della somiglianza con il corpo umano. Consiste nel fatto che il dispositivo stesso ha tre interruttori principali, in cui operano tre modalità principali ed aggiuntive. Il dispositivo ha funzioni di intelligenza artificiale.

- La prima modalità – è universale.
- La seconda modalità – è l'amplificazione della fase stazionaria della realtà.
- La terza modalità – è l'amplificazione della fase dinamica della realtà (ad impulsi periodici).  
La modalità ad impulsi periodici viene attivata dal circuito stesso del dispositivo.

Inoltre, è possibile attivare il laser ed il display OLED può essere attivato nella modalità di lettura delle serie numeriche. Uno dei laser è attivo costantemente, e l'altro opera insieme al sensore di movimento installato sulla superficie superiore del dispositivo. In assenza dell'utilizzatore, il secondo laser si spegne.

Premendo il pulsante si apre il file. I numeri, registrati su una scheda SD, appaiono sullo schermo.

---

## Avvertenza prima dell'utilizzo del dispositivo PRK-1UM

Prima di utilizzare il dispositivo dello sviluppo delle concentrazioni della vita eterna PRK-1UM modificato a tre modalità leggere il manuale d'uso di questo dispositivo e la descrizione del dispositivo alla pagina web: <https://pr.grigori-grabovoi.world/index.php/technical-devices/prk-1um>

La descrizione nella pagina web indicata è fornita in diverse lingue.

### Sicurezza e funzionamento:

si vada al link: <https://pr.grigori-grabovoi.world/index.php/technical-devices/prk-1um>

### AVVERTENZA:

Per evitare cortocircuiti elettrici e relative conseguenze, incluso il possibile incendio del dispositivo, non esporre il dispositivo all'umidità. Evitare di far cadere il dispositivo da una grande altezza.

### Norme:

Le informazioni sugli standards, i certificati, i marchi di conformità, la protezione del brevetto, i marchi relativi al dispositivo dello sviluppo delle concentrazioni della vita eterna PRK-1UM a tre modalità sono disponibili sul dispositivo stesso, nella documentazione fornita nella confezione e sul sito ufficiale: <https://pr.grigori-grabovoi.world>

### Repubblica di Serbia e Unione Europea. Informazioni sul riciclo dei materiali:

Un segno barrato del contenitore dell'immondizia sul dispositivo e nella documentazione indica che, in conformità con le leggi e le normative locali, questo prodotto deve essere smaltito separatamente dai rifiuti domestici.

### Avvertenza sul laser:

Questo dispositivo è conforme agli standard di sicurezza e, in conformità alle normative, è classificato come apparecchiatura con laser di classe 1 ( $\lambda = 650\text{nm}$ .  $P_o \leq 0,4 \text{ mW}$ ).

I laser di classe 1 sono a bassissima potenza, con un livello di radiazione incapace di creare danni all'occhio umano.

Il dispositivo PRK-1UM non è fonte di radiazioni laser dirette, poiché il raggio laser è limitato dall'involucro.

Sul dispositivo sono presenti la segnaletica standard e le informazioni sulla sicurezza delle radiazioni laser di Classe 1.



### L'alimentatore soddisfa i seguenti requisiti:

“Sulla sicurezza delle apparecchiature a bassa tensione” e “Compatibilità elettromagnetica delle apparecchiature tecniche”

### Dati del singolo dispositivo

Il numero del modello ed il numero di serie individuale del dispositivo si trovano sul pannello posteriore del dispositivo. Utilizzare questi numeri se è necessario contattare il produttore il cui indirizzo e sito Web sono disponibili sul pannello posteriore del dispositivo.

### Materiali utilizzati e prove

Nel dispositivo vengono usati materiali sicuri. Il dispositivo ha elementi e materiali di saldatura che non contengono piombo od altre sostanze nocive.

Ogni componente di ogni parte del dispositivo viene valutato attentamente per la sicurezza ambientale.

Ogni dispositivo viene testato per almeno 24 ore di funzionamento continuo prima dell'inizio del funzionamento in ciascuna delle tre modalità operative del dispositivo, il che garantisce le normali prestazioni del dispositivo.

## Istruzioni per l'accensione del dispositivo PRK-1UM

Installare il dispositivo su una superficie orizzontale.

Collegare alla rete elettrica con tensione di 220 (110) volt



oppure collegarlo a un caricabatterie portatile Power Bank.



Il dispositivo funziona in tre modalità.  
 Il dispositivo è spento quando tutti i pulsanti del dispositivo sono in posizione “giù”.

Foto 1: Il dispositivo è spento.



Foto 1.

La prima modalità si attiva premendo il pulsante 1 verso l'alto. Questo pulsante si illumina.

Foto 2: La prima modalità è attivata. I pulsanti (2 e 3) sono in posizione “giù”.



Foto 2.

La seconda modalità si attiva premendo il pulsante 2 verso l'alto. Questo pulsante si illumina.

Foto 3: Accensione della seconda modalità. Si effettua partendo dalla prima modalità. Pulsante (2) in posizione "su".



Foto 3.

La seconda modalità si manifesta con l'emissione di luce statica dal lato sinistro del dispositivo, all'interno del dispositivo. È controllata dall'accensione del LED trasparente a sinistra (foto 4).





Foto 4.

La terza modalità si attiva spegnendo e riaccendendo il pulsante 1, mentre il pulsante 2 rimane acceso (posizione alta). I pulsanti 1 e 2 si illuminano. Il pulsante 1 dovrebbe lampeggiare.

Foto 5: La terza modalità è attivata. Pulsante (2) in posizione “su”.



Foto 5.

Per determinare in quale modalità opera il dispositivo al momento, è sufficiente guardare il pulsante di commutazione della modalità (2).

Se il pulsante (2) non è acceso, il dispositivo funziona nella prima modalità (foto 2).

Se il pulsante (2) è acceso, il dispositivo funziona nella seconda modalità (foto 3).

Se il pulsante (1) lampeggia, il dispositivo funziona nella terza modalità.

Foto 6. Pulsante di accensione (3).



Foto 6.

Il pulsante (3) attiva funzioni aggiuntive del dispositivo. **Il pulsante (3) può essere acceso SOLO nella prima modalità e nella seconda modalità di funzionamento del dispositivo.** In questo modo si accendono due laser (foto 7) e il display OLED o diodo LED sul lato destro del pannello frontale.



Foto 7.

Uno dei due laser è acceso in modo continuo, mentre il secondo funziona insieme al sensore di movimento, installato sulla superficie superiore del dispositivo. In assenza di utenti, il secondo laser si spegne (foto 8).

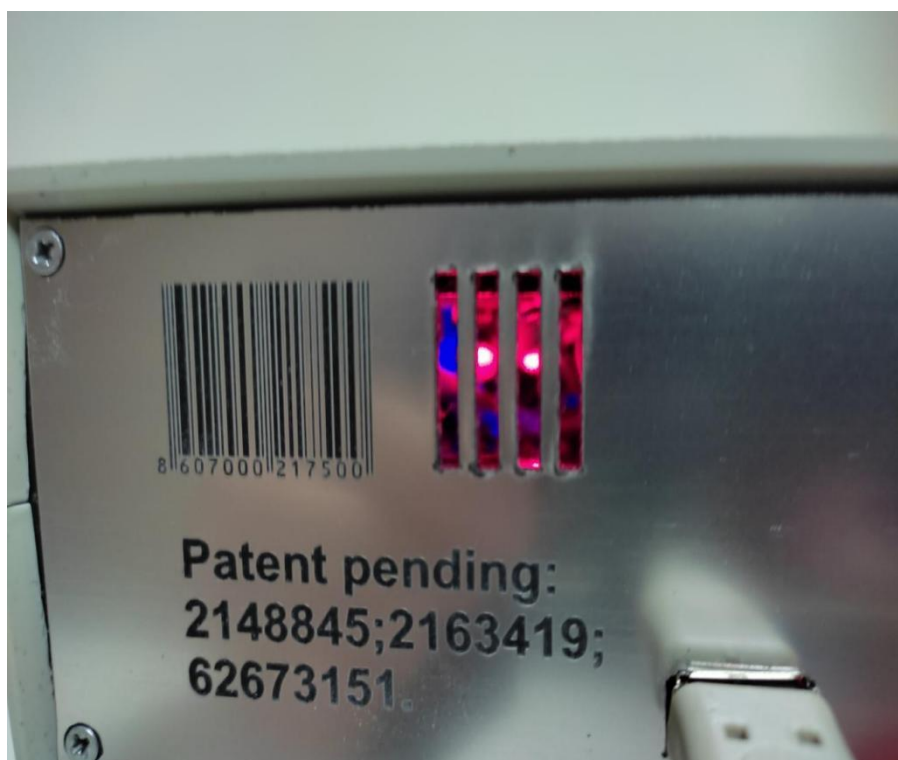

Foto 8.

E si accende quando l'utente si trova a una distanza inferiore a 3 metri dal dispositivo. Inoltre, è possibile utilizzare serie numeriche. A tale scopo, la serie numerica necessaria viene registrata sulla scheda SD. La scheda viene inserita in un apposito scomparto sul pannello frontale a destra (foto 9).

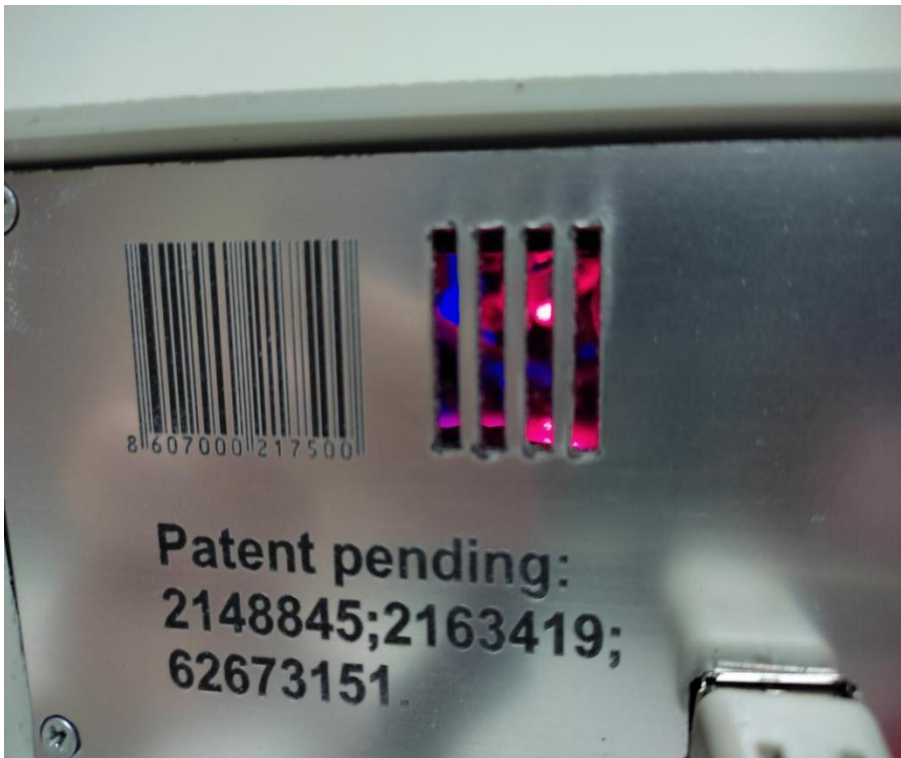

Foto 9.

Per leggere le serie numeriche da una scheda SD, è possibile utilizzare il display OLED oppure monitorare l'uscita delle serie numeriche dalla scheda SD tramite il funzionamento periodico a impulsi del LED. Nel primo caso, è necessario spegnere il pulsante (3), inserire la

scheda e accendere il pulsante (3). Le scritte appaiono sul display (foto 10) oppure il diodo LED inizierà a lampeggiare (foto 11).



Foto 10.



Foto 11.

Per cambiare la funzione dello schermo o del LED, è necessario premere il pulsante grande a destra dello schermo.

Per leggere le informazioni sullo schermo, premendo il pulsante superiore a sinistra del display, si sposta il cursore in basso fino al nome del file 1.TXT (foto 12).



Foto 12.

Premendo il pulsante in basso si apre il file. Sullo schermo appaiono le serie numeriche registrate sulla scheda SD (foto 13).



Foto 13.

Per attivare la modalità di lettura delle serie numeriche tramite LED, è necessario premere il pulsante grande a destra dello schermo. Il LED, situato sul pannello frontale del dispositivo sul lato destro, inizia a pulsare con frequenza e intensità che corrispondono al numero letto (foto 14).



Foto 14.

Per spegnere il dispositivo, è necessario disattivare i pulsanti (1), (2) e (3).

## **Funzionamento del dispositivo PRK-1UM in modalità di utilizzo della scheda SD**

### **1) Prima accensione del dispositivo in modalità scheda SD.**

Quando la modalità di funzionamento della scheda SD viene attivata per la prima volta, il contenuto della scheda SD viene visualizzato sullo schermo.

Dopo che l'utente ha caricato sullo schermo la serie numerica dalla scheda SD selezionando il file '1.txt', la serie numerica caricata viene visualizzata sullo schermo. Premendo il pulsante a destra dello schermo, il LED sulla destra inizia a lampeggiare.

### **2) Accensione del dispositivo per la seconda e le successive volte in modalità scheda SD.**

Quando si accende il dispositivo per la seconda volta in modalità scheda SD, la serie numerica viene letta automaticamente dalla scheda SD e il LED a destra inizia a lampeggiare e sullo schermo viene visualizzata la dicitura "Init SD... OPEN".

Se il LED a destra lampeggia, vuol dire che il dispositivo ha letto automaticamente la scheda SD (e il file '1.txt') e sta funzionando in modalità normale.

### **3) Come visualizzare nuovamente il contenuto della scheda SD sullo schermo:**

- spegnere la modalità scheda SD (pulsante 3), quindi premere il pulsante a destra dello schermo e attivare nuovamente la modalità scheda SD (pulsante 3).

Successivamente, il contenuto della scheda SD verrà visualizzato sullo schermo. In seguito, per visualizzare la serie numerica sullo schermo, è necessario eseguire i passaggi descritti nelle istruzioni (sezione relativa alla selezione del file '1.txt') e poi premere il pulsante a destra dello schermo per far lampeggiare il LED.

## **Descrizione del dispositivo dello sviluppo delle concentrazioni della vita eterna PRK-1UM modificato a tre modalità**

Lo sviluppo delle concentrazioni, per l'ottenimento della vita eterna per tutti, è realizzato mediante la concentrazione sul ricevitore di bio-segnali generati, contemporaneamente al pilotaggio finalizzato al raggiungimento del risultato delle concentrazioni stesse. E' cosa nota in psicologia che più a lungo la concentrazione viene effettuata, più velocemente l'obiettivo viene raggiunto e gli eventi risultano ottimizzati.

Il dispositivo, in aggiunta a questo fattore della psicologia, in accordo con la legge delle connessioni universali, aiuta il pilotaggio verso l'obiettivo della concentrazione attraverso la sovrapposizione di campi elettromagnetici ai campi provenienti dalla generazione dei bio-segnali. Il dispositivo sviluppa le concentrazioni di pilotaggio creativo.

Nella teoria della sintesi ondulatoria che l' emissione generata dal pensiero può esistere in due stati quantici contemporaneamente. Uno di questi stati si trova sull'elemento sensore del trasmettitore dei segnali e l'altro sul ricevitore dei segnali. In questo modo è possibile la creazione di dispositivi per garantire la vita eterna che interagiscono con il pensiero. Nelle invenzioni brevettate di Grigori Grabovoi è scritto che l'operatore umano genera informazioni sotto forma di emissione di pensiero.

Per attivare le funzioni del dispositivo "PRK-1UM" una persona concentra un'emissione di pensiero creativo sulle lenti che si trovano sulla superficie superiore del dispositivo.

Il pensiero contiene un obiettivo di concentrazione. L'azione della concentrazione riguardo il tempo attuale e futuro è fatta sull'elemento sensore del trasmettitore di segnali, costituito da lenti. I movimenti circolari delle concentrazioni vengono effettuati a partire dalla lente di più piccolo diametro in senso antiorario verso le lenti di diametro maggiore.

Per le concentrazioni relative agli eventi del passato, il moto circolare del pensiero di concentrazione è eseguito in senso orario dalla lente più piccola verso quelle più grandi. E il raggio di concentrazione in questo caso non viene da sopra, come nel caso delle concentrazioni per il tempo attuale e futuro, ma viene dal gruppo ottico interno del dispositivo.

In accordo con il sistema di trasmissione delle informazioni descritto nel brevetto, il secondo stato quantico del pensiero viene proiettato sul ricevitore di segnali, strutturato in forma di dispositivo ottico all'interno del dispositivo.

La realizzazione del metodo di normalizzazione, durante la concentrazione descritta nel brevetto "Metodo di prevenzione delle catastrofi e dei dispositivi per la sua realizzazione" viene effettuata attraverso la sovrapposizione dei campi generati da bio-segnali, campi elettromagnetici. Oltre al fattore psicologico secondo la legge di azione delle connessioni universali, viene aggiunto un controllo dell'obiettivo della concentrazione.

Il dispositivo funziona universalmente per lo sviluppo delle seguenti concentrazioni che descrivono la vita eterna:

Pilotaggio 1:

Sviluppo delle concentrazioni della vita eterna per qualsiasi evento.

Pilotaggio 2:

Sviluppo di concentrazioni della vita eterna per la chiaroveggenza pilotante.

Pilotaggio 3:

Sviluppo delle concentrazioni della vita eterna per la previsione pilotante.

Pilotaggio 4:

Sviluppo delle concentrazioni della vita eterna per il ringiovanimento.

**Sviluppando le concentrazioni della vita eterna con il dispositivo, è necessario padroneggiare le tecnologie realizzabili tramite lo sviluppo spirituale o della chiaroveggenza di controllo. Per poter fare lo stesso, includendo processi di protezione e normalizzazione della salute, tramite le concentrazioni della propria coscienza.**

Nel dispositivo PRK-1UM modificato, sono state aggiunte le nuove funzioni seguenti alle funzioni del PRK-1U, secondo la teoria della sintesi ondulatoria creata da Grigori Grabovoi:

1. È stata aumentata la potenza della funzione di lavoro autonomo senza concentrazione. Una concentrazione piccola o anche non prolungata è molto più rafforzata che nel PRK-1U. Una concentrazione lunga è rafforzata di molte volte da varie progressioni.

2. La dinamica della materia opera nell'ambiente statico tramite la scheda SD e i LED. L'onda statica della realtà sotto forma di materia fisica volumetrica e la corrente elettrica come onda dinamica della realtà che esce su un impulso luminoso con la dispersione della luce nell'ambiente esterno, cioè infinito.

3. All'interno del dispositivo, opera un laser sicuro ad operatività continua come onda statica della realtà, con le proprietà del laser nelle aree ad alta intensità di radiazione all'interno del raggio laser con la dispersione attraverso le lenti nell'infinito, nell'ambiente eterno. La funzione di onda dinamica della realtà opera da un secondo laser all'interno del dispositivo, che viene attivato da un sensore di movimento.

4. Attraverso la scheda SD, tramite il software della scheda Arduino NANO, si realizza la transizione della materia nell'ambiente eterno infinito, attraverso un numero sul display o il LED. Ogni modalità di funzionamento del dispositivo in connessione con l'operatività dell'intelligenza artificiale è rafforzata dalla scheda SD.

Usando i numeri sulla scheda SD, è possibile condurre le concentrazioni con il controllo desiderato al livello richiesto. Le serie numeriche possono essere aggiunte periodicamente alla scheda SD. Una serie numerica registrata sulla scheda SD non viene rimossa durante il montaggio in fabbrica del dispositivo. A quella serie numerica i Sublicenziatari possono aggiungere serie numeriche individuali dal loro computer alla scheda SD, serie numeriche dalle opere dell'autore di Grigori Grabovoi. Tramite questo, viene assicurato lo sviluppo delle concentrazioni della vita eterna per sé stessi e per tutti nelle aree selezionate.



5. Sulla superficie superiore della custodia del dispositivo c'è un compasso, con un segno della posizione dell'ago del compasso parallelamente ai raggi dei laser all'interno del dispositivo. È raccomandabile avviare la posizione iniziale per l'uso del PRK-1UM quando l'ago del compasso è puntato sul segno. Successivamente è possibile selezionare la posizione individuale dell'ago del compasso. Secondo il processo della sintesi ondulatoria, la scheda SD realizza la transizione dell'elettrone nell'ambiente infinito attraverso il numero sul display. La terza modalità, grazie all'operatività dell'intelligenza artificiale, può richiedere l'utilizzo dei numeri sulla scheda SD. Poiché quando si ferma la terza modalità, la concentrazione sui numeri della scheda SD consente di simulare l'operatività della terza modalità. Il confronto tra l'operatività della terza modalità e la versione simulata consente di sviluppare le concentrazioni della vita eterna in modo accelerato.

In questo modo è possibile realizzare gli obiettivi del controllo più rapidamente sviluppando e rafforzando più velocemente le concentrazioni dei modelli mentali degli eventi.

Il nuovo dispositivo PRK-1UM modificato ha dimensioni ridotte di cm 20x16x6,5, adatte per l'uso mobile, ed è in grado di essere alimentato sia dalla rete elettrica sia da un caricatore Power bank portatile

Il dispositivo modificato PRK-1UM si differenzia in dettaglio dal PRK-1U per la presenza delle seguenti parti che forniscono funzioni aggiuntive del PRK-1UM:

1. Schede Arduino Nano V3, mini-controllore ATmega168 -16 MHz, chip CH340G (2 pezzi), che sono strumenti software e hardware per la costruzione di sistemi nel campo dell'elettronica e della robotica. **La parte software** consiste in una schermata software (IDE) per la scrittura di programmi, la loro compilazione e la programmazione hardware. **La parte hardware** è costituita da un insieme di circuiti stampati assemblati. Il linguaggio di programmazione di Arduino è il C++ con la struttura di cablaggio. L'autore del programma implementato è Grigori Petrovich Grabovoi.
2. Adattatore SD.
3. Schermo OLED per la visualizzazione delle serie numeriche dalla scheda SD sotto forma di testo.
4. LED per la visualizzazione delle serie numeriche della scheda SD sotto forma di impulsi luminosi.
5. Laser (2 pezzi).
6. Sensore di movimento.
7. Bussola.
8. Micro pulsanti (2 pezzi)
9. Interruttore a pulsante n. 3.
10. Pulsante di commutazione della posizione.
11. Connettore USB per il collegamento dell'alimentazione esterna al dispositivo.
12. Cavo di alimentazione collegato tramite connettore USB.

#### **L'inventore del dispositivo "PRK-1UM":**

Grigori Petrovich Grabovoi.

#### **Il produttore del dispositivo è**

l'impresa individuale "GRIGORII GRABOVOI PR KONSALTING TECHNOLOGIES OF ETERNAL DEVELOPMENT" che opera sulla base del certificato di registrazione statale dell'individuo Grigori Petrovich Grabovoi come impresa individuale N° 63983276 emesso il 21 settembre 2015 da parte dell'Agenzia per la registrazione delle imprese della Repubblica di Serbia.

## Informazioni su certificati, brevetti e marchi

Il dispositivo dello sviluppo delle concentrazioni della vita eterna PRK-1UM a tre modalità ha subito i test di compatibilità elettromagnetica nel laboratorio nazionale "Idivorsky Laboratories" (<http://www.idvorsky.com>) presso l'Istituto nazionale "Istituto Mihailo Pupin" (IMP) (<http://www.pupin.rs/en/home/>), che è subordinato al Ministero delle Scienze della Repubblica di Serbia.

I test di compatibilità elettromagnetica del dispositivo dello sviluppo delle concentrazioni della vita eterna PRK-1UM a tre modalità sono stati sottoposti ai "Laboratori Idivorsky" nel pieno rispetto della Direttiva sulla compatibilità elettromagnetica dell'Unione europea. Pertanto, il certificato ottenuto sui parametri normali del dispositivo PRK-1UM, rilasciato dai "Laboratori Idivorsky", ai sensi delle Direttive dell'Unione Europea in conformità con il diritto internazionale, consente di apporre i marchi AAA, CE sul dispositivo.

"Idivorsky Laboratories" è stato nominato dal Ministero dell'Economia della Serbia per il rilascio di tali certificati per la vendita di dispositivi con caratteristiche nell'ambito delle direttive dell'Unione Europea, pertanto non vi sono restrizioni all'uso dei dispositivi PRK-1UM nell'Unione Europea.

Il rapporto "Idivorsky Laboratories" in inglese sui test del dispositivo dello sviluppo delle concentrazioni della vita eterna PRK-1UM a tre modalità, con la conclusione che le caratteristiche di questo dispositivo soddisfano gli standard dell'Unione Europea sono riportate sul sito Web, che è scritto sul pannello posteriore del dispositivo, nella pagina del sito Web:

Rapporto principale di "Idivorski Laboratorije" sui test del dispositivo PRK-1UM: [https://pr.grigori-grabovoi.world/images/PRK1UM/EMC\\_Test\\_Report\\_Idivorski\\_Lab\\_PRK-1UM\\_en.pdf](https://pr.grigori-grabovoi.world/images/PRK1UM/EMC_Test_Report_Idivorski_Lab_PRK-1UM_en.pdf)

Secondo rapporto di "Idivorski Laboratorije" sui test del dispositivo PRK-1UM con un laser di classe 1:

[https://pr.grigori-grabovoi.world/images/PRK1UM/EMC\\_Test\\_Report\\_Idivorski\\_Lab\\_part\\_new\\_laser\\_PRK-1UM\\_en.pdf](https://pr.grigori-grabovoi.world/images/PRK1UM/EMC_Test_Report_Idivorski_Lab_part_new_laser_PRK-1UM_en.pdf)

Il dispositivo dello sviluppo delle concentrazioni della vita eterna PRK-1UM a tre modalità è stato sottoposto a test di sicurezza completi nel laboratorio ANL. C'è la marcatura CE, che si riferisce a tutto il dispositivo, insieme ai dispositivi di alimentazione elettrica.

Il rapporto di laboratorio ANL in inglese sui test del dispositivo dello sviluppo delle concentrazioni della vita eterna PRK-1UM a tre modalità, con la conclusione che le caratteristiche di questo dispositivo soddisfano gli standard dell'Unione europea, è disponibile sul sito web, scritto sul pannello posteriore del dispositivo, nella pagina del sito Web:

[https://pr.grigori-grabovoi.world/images/PRK1UM/Test\\_Report\\_AN\\_LAB\\_CO\\_PRK-1UM\\_en.pdf](https://pr.grigori-grabovoi.world/images/PRK1UM/Test_Report_AN_LAB_CO_PRK-1UM_en.pdf)

I certificati, ottenuti sulla base di questi rapporti, sono riportati nella pagina del sito Web:

<https://pr.grigori-grabovoi.world/index.php/technical-devices/prk-1um>

Grigorii Petrovich Grabovoi ha registrato il "Dispositivo per lo sviluppo di concentrazioni di vita eterna PRK-1UM a tre modalità" presso l'Ufficio brevetti e marchi tedesco (DPMA) come modello di utilità

<https://register.dpma.de/DPMAregister/pat/PatSchrifteneinsicht?docId=DE202024103073U1>.

Durante la registrazione, è stato applicato il principio di controllo, espandendo il nome del dispositivo tecnico a un nome contenente la funzione per la vita eterna.

Il dispositivo per lo sviluppo di concentrazioni di vita eterna PRK-1UM three-mode" si riferisce alla modifica del "Dispositivo per lo sviluppo di concentrazioni di vita eterna PRK-1U three-mode", che è scritto in forma abbreviata nella lettera "M" (Modificato). Pertanto, è anche protetto da un brevetto per un'invenzione rilasciato a Grigori Grabovoi dall'US Patent and Trademark Office il 19 novembre 2024 con priorità dal 9 luglio 2018, poiché questo brevetto contemporaneamente alla protezione del PRK-1U protegge, in conformità con la descrizione dettagliata del brevetto, anche la modifica del PRK-1U.

Informazioni sul brevetto dell'invenzione sul sito web dell'US Patent and Trademark Office: <https://patentcenter.uspto.gov/applications/16504293>

I dati sulle invenzioni, con numeri di protezione brevettuale, sono scritti sull'alloggiamento del dispositivo: «Manufactured under invention patents: US 12,144,599 B2; 2148845; 2163419.».

Il dispositivo è prodotto con i marchi GRABOVOI® e GRIGORI GRABOVOI®.

## Prova di operatività del dispositivo PRK-1U

Sulla questione dell'operatività del Dispositivo dello sviluppo delle concentrazioni PRK-1U, è riportato, che l'operatività di questo dispositivo dello sviluppo delle concentrazioni della vita eterna è oggettivamente stabilita da quanto segue:

1. Teoria fisico-matematica, calcoli matematici, risultati di esperimenti, confermati da numerosi medici di scienze fisico-matematiche e tecniche, che sono membri del comitato editoriale della rivista "Electronic Equipment", e pubblicati nella stessa rivista: <https://licenzija8.wordpress.com/science/>
2. Brevetti delle invenzioni di Grigori Grabovoi: <https://licenzija8.wordpress.com/patents/>, <https://grigori-grabovoi.tech/patents-it>
3. Protocolli video di test del dispositivo con buoni risultati sistematici, che tutti i partecipanti registrati ai test, senza eccezioni, 128 partecipanti, hanno eseguito: <https://pr.grigori-grabovoi.world/index.php/technical-devices/video-testimonials>
4. Protocolli firmati di test riusciti del dispositivo: <http://pr.grigori-grabovoi.world/index.php/technical-devices/written-testimonials>
5. Un periodo di oltre otto anni con centinaia di test e funzionamento del dispositivo senza risultati negativi, con numerosi risultati positivi: <https://grigori-grabovoi.tech/prk1u-results-it>

## **Risultati dell'uso del dispositivo dello sviluppo delle concentrazioni della vita eterna PRK-1U**

Una breve raccolta di risultati sull'utilizzo del Dispositivo dello sviluppo delle concentrazioni della vita eterna PRK-1U.

La parte 1 e la parte 2 possono essere scaricate sui link:

<https://pr.grigori-grabovoi.world/index.php/technical-devices/testimonies-prk-1u>

<http://educenter.grigori-grabovoi.world/course/index.php?categoryid=30>

I risultati dell'utilizzo del dispositivo, tradotti in diverse lingue, si possono leggere al link

<https://grigori-grabovoi.tech/prk1u-results-it>

## **Metodologie di lavoro con il dispositivo dello sviluppo delle concentrazioni della vita eterna PRK-1U**

I metodi di utilizzo consistono in: la concentrazione sull'obiettivo di pilotaggio 1, 2, 3, 4 viene eseguita nell'intervallo di tempo da 1 a 3 minuti e, se necessario, più a lungo, senza il dispositivo acceso e quando il dispositivo è acceso. I risultati vengono confrontati in termini di effetto dello sviluppo di concentrazioni che assicurano la vita eterna. Questo effetto viene utilizzato per lo sviluppo di concentrazioni in direzioni specifiche attraverso l'uso ripetuto del dispositivo.

### **Sviluppo delle concentrazioni della vita eterna per il RINGIOVANIMENTO**

1.1. Potete effettuare la concentrazione per il vostro ringiovanimento personale, successivamente, per il ringiovanimento di altre persone. Se pensate di essere sufficientemente giovane e quindi di non aver bisogno di lavorare sul ringiovanimento, allora potete utilizzare questa concentrazione come allenamento. In questo modo, quando in futuro vorrete ringiovanire, voi saprete già come fare.

#### **Il metodo:**

Quando effettuate questa concentrazione potete visualizzare voi stessi all'età desiderata e durante la concentrazione dovete cercare di percepirla ad un punto tale per cui, realmente, sentite che quella è la vostra età.

1.2. Anche le persone giovani hanno bisogno di praticare questa concentrazione, per il futuro, in modo che ognuno possa ringiovanire se stesso in ogni momento. Questo significa che dovremmo imparare fin da giovani. In questa concentrazione è necessario focalizzare l'attenzione sulla colonna vertebrale e, vicino alla colonna visualizzare i numeri **498**. In questo modo dovete ringiovanire voi stessi utilizzando il bagliore di questi numeri. In altre parole, la luce dei numeri va verso e dentro la colonna vertebrale, e attraverso questa voi potete ringiovanire. Completamente.

1.3. La materia della vita eterna generata dal dispositivo esce dallo spazio tra le lenti. E' emessa dallo spazio tra le lenti. Dovete portare la materia della vita eterna dentro la zona del vostro coccige, in modo tale che questa risalga fino a raggiungere il vostro cervello e, contemporaneamente dell'altra quantità di materia, proveniente dalla lente piccola, entri

attraverso l'occhio destro ed il sinistro, per raggiungere la materia che proviene dal coccige, in modo tale da chiudere il circuito.

- 1.4 Bisogna portare la materia della vita eterna dallo spazio centrale tra le lenti direttamente dentro il cervello. Da lì, dentro il midollo osseo (negli arti). E attraverso di esso, in ogni cellula del corpo.

## **2 Sviluppo delle concentrazioni della vita eterna per QUALSIASI EVENTO**

- 2.1 Per prima cosa è necessario concentrarsi su un punto specifico, o un'area del proprio corpo, per portare la norma.

Poi la stessa concentrazione può essere fatta per altre aree.

Dopo di che potete concentrarvi su qualunque evento.

- 2.2 In questa concentrazione, è necessario trasferire un elemento della vostra coscienza nell'infinito futuro, e da questo futuro infinito vedere che gli eventi che avete pianificato siano stati realizzati. Per esempio: dal presente osservate il passato, e lì, gli eventi desiderati si sono realizzati come volevate che accadessero, qui è la stessa cosa: dal futuro guardate il passato, che è il presente, ma è il passato in relazione al futuro. Oppure, se prendiamo in considerazione un futuro remoto, allora si tratta di entrambi: un evento futuro che accade prima di un altro elemento futuro, che diventa passato per l'elemento successivo. Di conseguenza risulta che è necessario guardare indietro. Da un futuro infinito guardate indietro e vedete che gli eventi desiderati sono stati realizzati.

## **3 Sviluppo delle concentrazioni della vita eterna per la CHIAROVEGGENZA PILOTANTE**

Per prima cosa è necessario applicare la chiaroveggenza pilotante per vedere, nel momento presente, la stanza o il luogo che avete lasciato, o visitato qualche ora fa. Poi, potete applicare la chiaroveggenza pilotante per ogni evento. E' consigliabile che voi definiate uno scopo di pilotaggio che volete veramente raggiungere.

### **Raccomandazioni:**

Durante la visualizzazione degli eventi, quando si applica la concentrazione con la chiaroveggenza pilotante, se necessario, simultaneamente si possono correggere gli eventi, perché la chiaroveggenza pilotante differisce dalla semplice chiaroveggenza per il fatto che, quando la si usa per la visualizzazione degli eventi, contemporaneamente, se è necessario, li corregge e li migliora per garantire la vita eterna.

## **4 Sviluppo delle concentrazioni della vita eterna per la PREVISIONE PILOTANTE**

Il pilotaggio con la previsione pilotante dovrebbe anche includere il seguente scopo di pilotaggio, che è quello di sviluppare la coscienza e lo spirito con l'aiuto del dispositivo, in modo che in futuro si possa pilotare senza il dispositivo, avendo sviluppato lo spirito e la coscienza.

### **Il metodo:**

In questa concentrazione bisogna visualizzare il proprio futuro infinito, il futuro eterno e vedere in questo futuro eterno, per esempio, fra un milione di anni, o in qualsiasi punto del futuro infinito, vedere concretamente qualche evento che vi riguarda. Vedere esattamente che cosa state facendo lì. E allo stesso tempo, è necessario diagnosticare, dal tempo presente, lo stato del vostro livello cellulare, ad es. lo stato delle cellule dell'organismo, le funzioni corporee – per esaminare ed essere certi che tutto è normale in quel futuro infinito. È meglio creare subito la norma, nel tempo corrente.

Altre metodologie di lavoro con il dispositivo PRK-1U sono pubblicate su Internet sulla pagina web <http://educenter.grigori-grabovoi.world/course/index.php?categoryid=29>

## **Giustificazione del prezzo dell'accordo di Sublicenza per il Programma Educativo con PRK-1UM**

In base all'Accordo di Sublicenza per l'oggetto della proprietà intellettuale, viene informato quanto segue:

- Tutti i materiali del Programma di istruzione in diverse lingue su flashcard;
- Assemblaggio del dispositivo PRK-1UM con dati ottici individuali;
- Fornire il diritto di utilizzare PRK-1UM per 4 anni e oltre sulla risorsa esistente o con un aggiornamento dopo 4 anni in base a un accordo aggiuntivo;
- Fornitura del diritto di utilizzo dell'account web con il dispositivo di raddoppio e amplificazione PRK-1UM per 4 anni;
- Prevedendo l'accesso quadriennale alla Biblioteca del Centro Educativo che contiene tutti i materiali del Programma Educativo, e con il costante caricamento di tutti i nuovi materiali da parte di G.P. Grabovoi.

Il prezzo dei materiali, caricati sulla flashcard, secondo il prezzo per il quale vengono venduti con successo su Amazon da diversi anni, negli internet shop [www.ggrig.com](http://www.ggrig.com), [www.grigori-grabovoi.center](http://www.grigori-grabovoi.center) (per es., il valore di mercato dei materiali del programma educativo) è di 10280 euro (informazioni al momento del 2016, ora il costo dei materiali è più alto).

Report sulle vendite di Amazon

<https://drive.google.com/file/d/1tYFMiSVfmsK3zDP1rskYdwUMjg-MEWQw/view>

L'accesso alla Biblioteca del Centro Educativo per 4 anni è stimato con un prezzo comparabile. Poiché l'abbonamento annuale alla Biblioteca del Centro Educativo (informazioni sul sito [www.grigori-grabovoi.world](http://www.grigori-grabovoi.world)) costa 2500 euro, l'importo dell'abbonamento per 4 anni è, rispettivamente, 10000 euro.

Fatture per il pagamento dell'accesso alla biblioteca e estratto conto attestante l'avvenuto pagamento delle fatture

<https://drive.google.com/file/d/1MTzrQcUI6xAh6NJTXARy48BxE7Stzf/view>

L'assemblaggio del dispositivo PRK-1UM con dati ottici individuali, che prevede il diritto di utilizzare PRK-1UM per 4 anni e oltre, e inoltre, il diritto di utilizzare l'account Web con il dispositivo duplicato e amplificato PRK-1UM per 4 anni, consistono in spese comparabili. Queste spese comprendono il costo della manodopera per il calcolo fisico-matematico, per la programmazione, il valore del costo della consegna, il montaggio e altre opere. In totale, si ottiene un prezzo analogo.

Pertanto, per il prezzo dell'accordo, viene fornito il pacchetto di valore molto più elevato, considerando anche il costante aggiornamento della Library of the Education Center e la possibilità di aggiungere modifiche al dispositivo.

In conformità con l'esperto approccio alla valutazione della proprietà intellettuale di B.B. Leontiev è stabilito quanto segue:

Qualsiasi oggetto di proprietà intellettuale dovrebbe essere inteso come indipendente e integrato nel sistema aziendale di conoscenza. Ogni oggetto di proprietà combina qualità che consentono di distinguerlo non solo per tipo e categoria, ad esempio una proprietà intellettuale, un brevetto, un know-how, un trasferimento tecnologico, regolato dagli articoli del codice civile, ma anche per identificarlo dalla posizione legale e tenendo conto della quantità di benefici ricevuti da essa. Qualsiasi risultato qualitativo dell'attività intellettuale nell'ambito delle pubbliche relazioni diventa oggetto di proprietà intellettuale, che ha almeno tre gruppi di criteri: tecnico (o artistico), giuridico ed economico.

Inizialmente, l'oggetto della proprietà è caratterizzato da contenuti di qualità tecnica, che consente di valutarlo in termini di uso funzionale. Queste sono le qualità tecniche di base: idoneità funzionale, usura, risorsa. L'idoneità di tutte le opere di Grigori Grabovoi è dimostrata dai risultati delle opere, che sono formalmente documentati e riportati nel volume "Practice of Control" in tre volumi. La via della salvezza ". Le opere di Grigori Grabovoi non si logorano dal punto di vista della loro lettura ripetuta, dal momento che ci sono numerose prove che dopo la ripetuta e molte volte lettura delle opere di Grigori Grabovoi, le tecnologie fornite nelle opere sono padroneggiate più profondamente e inoltre, il materiale è compreso in modi nuovi. Ciò accade in connessione con l'ideologia e la pratica di assicurare la vita eterna poichè tutto ciò è incorporato nei testi delle opere di Grigori Grabovoi, lavorare con i quali porta al risultato di garantire la vita eterna senza limiti di tempo. Ciò dimostra anche che le opere di Grigori Grabovoi hanno una risorsa infinita.

#### **L'idoneità del dispositivo dello sviluppo delle concentrazioni PRK-1UM è stabilita da quanto segue:**

1. I dati, forniti nella sezione "Prova dell'operatività del dispositivo" in questo opuscolo.
2. L'usura del dispositivo dello sviluppo delle concentrazioni PRK-1UM in relazione ai materiali utilizzati è insignificante.
3. La risorsa del dispositivo dello sviluppo delle concentrazioni PRK-1UM è illimitata nel tempo, poiché il dispositivo sviluppa concentrazioni in base all'attuale livello dello sviluppo delle concentrazioni durante l'uso del dispositivo.
4. Inoltre, l'oggetto della proprietà è caratterizzato da criteri spazio-temporali nell'ambito della legge e dell'economia. Le relazioni economiche e giuridiche sono interdipendenti e non è appropriato esaminarle separatamente.

Nella sfera del diritto, la caratteristica dello spazio è il territorio dell'azione, quello temporaneo è il termine di validità, che determina i parametri del turnover civile di questo oggetto di diritto. La principale caratteristica giuridica dell'oggetto di proprietà è la qualità della protezione giuridica, da cui deriva il potenziale per la protezione qualitativa. Di maggiore qualità è la protezione legale, più efficace può essere la protezione di questo oggetto di proprietà dagli utenti disonesti. La protezione viene posta nella fase di creazione dell'oggetto e viene rafforzata nella fase del suo utilizzo. Tuttavia, è spesso necessario proteggere dall'abuso gli oggetti più interessanti della proprietà nella fase di creazione, ma più spesso ancora nella fase di utilizzo.

La modalità spazio-temporale di sicurezza e protezione è tanto più urgente quanto maggiore è la qualità del contenuto dell'oggetto di proprietà, ovvero più efficace è il suo contenuto tecnico, che è sempre primario. Pertanto, ingegneri e scienziati altamente qualificati dovrebbero lavorare in contatto con esperti di brevetti altamente qualificati, e avvocati, per garantire che l'elevata qualità legale della protezione, che è assegnata a questo oggetto,

corrisponda all'elevata qualità tecnica. La dotazione legale dell'oggetto di proprietà, espresso dalle modalità di sicurezza e protezione dell'oggetto, personifica l'idea di giustizia in esso. Come dimostrano i fatti, Grigori Grabovoi ha tenuto conto dei dati di cui sopra a difesa della sua proprietà intellettuale.

Le opere di Grigori Grabovoi sono protette dalla registrazione in varie strutture per la registrazione del copyright, incluso l'Ufficio di registrazione del copyright della Library of Congress of USA: TX 7-324-403 del 06 febbraio 2008, 1-607-600 dell'8 febbraio 2008, TX 7-049-203 del 12 febbraio 2008, TX 6-975-628 del 13 febbraio 2008 (visualizzare i dati sul sito ufficiale in una rete di Internet: TX0006975628 / 2008-02-13), TXu 1 - 789 -751 del 25 luglio 2011. L'indirizzo del sito ufficiale, l'ufficio Copyright della Library of Congress contenente i dati di registrazione <http://www.cocatalog.log.gov> Indirizzo dell'ufficio Copyright della Library of Congress degli Stati Uniti States of America è la Library of Congress degli Stati Uniti, il Copyright Office, 101 Independence Avenue SE Washington, DC 20559-6000.

## Modulo dell'accordo di agenzia per il diritto di organizzare accordi di Sublicenza per il Programma Educativo con PRK-1UM

UGOVOR O NALOGU broj _____ Beograd « _____ » _____ 20 _____.	CONTRATTO DI MANDATO numero _____ Belgrado Il « _____ » _____ 20 _____.
Individualni preduzetnik «Grigorii Grabovoi PR KONSALTING TECHNOLOGIES OF ETERNAL DEVELOPMENT», koji obavlja svoju delatnot na osnovu potvrde o državnoj registraciji fizičkog lica Grigorii Grabovoi kao individualnog preduzetnika od 21. septembra 2015. godine broj 63983276 izdatog od strane Agencije za priredne registre Republike Srbije, u daljem tekstu «Davalac naloga», sa jedne strane, i  _____ _____ u daljem tekstu «Primalac naloga», sa druge strane, zajedno u daljem tekstu Strane, zaključili su ovaj građansko-pravni ugovor kako sledi:	L'Imprenditore individuale "Grigorii Grabovoi PR KONSALTING TECHNOLOGIES OF ETERNAL DEVELOPMENT", che svolge la sua attività sulla base del Certificato di registrazione statale delle persone fisiche Grigorii Grabovoi nella sua qualità d'imprenditore individuale dal 21 settembre 2015, numero 63983276 rilasciato dall'Agenzia per il Registro delle Imprese della Repubblica Serbia, di seguito denominato "Il Mandante", da una parte, e  _____ _____ di seguito denominato "Il Mandatario", d'altra parte, insieme appresso denominati le Parti, hanno concluso il presente Contratto civile-legale come segue:
<b>1. PREDMET UGOVORA</b>	<b>1. OGGETTO DEL CONTRATTO</b>
1.1. Davalac naloga daje nalog, a Primalac naloga se obavezuje da u ime Davaoca naloga izvrši sledeće:	1.1. Il Mandante dà l'ordine, e il Mandatario si impegna di eseguire per conto del Mandante le seguenti operazioni:
1.1.1. Da organizuje plasman i potpisivanje ugovora o sublicenci za korišćenje Obrazovnog Programa po Učenju Grigorija Grabovoja sa uređajem za razvoj koncentracija PRK-1UM.	1.1.1. Di organizzare il posizionamento sul mercato e la firma del presente Contratto di sublicenza per l'utilizzo del Programma di Formazione secondo gli Insegnamenti di Grigori Grabovoi con il dispositivo per il sviluppo della concentrazione PRK-1UM.
1.1.2. Da vrši prevođenje, sprovodi testiranje PRK-1UM, obavlja konsultacije sa Korisnikom podlicence do ispunjenja uslova ugovora, da organizuje isplate.	1.1.2. Di fare traduzioni, di condurre le prove PRK- 1UM, di svolgere le consultazioni con il Sublicenziatario per l'adempimento delle condizioni contrattuali, di organizzare i pagamenti.



1.1.3. Da pronalazi fizička i pravna lica – potencijalne Korisnike podlicence preko Internet resursa i na druge načine.	1.1.3. Di trovare le persone fisiche e giuridiche – i potenziali Sublicenziatari tramite le risorse di Internet e in altri modi.
1.1.4. Da organizuje potpisivanje sa Davaocem naloga ugovora o podlicenci za korišćenje dela Grigorija Grabovoja za održavanje seminara po njima, njihovog izdavanja, za korišćenje njegovih robnih znakova GRABOVOI® i GRIGORI GRABOVOI®.	1.1.4. Di organizzare la firma del Contratto di sub- licenza con il Mandante per l'utilizzo di opere di Grigori Grabovoi al fine di organizzare i seminari secondo le sue opere, ai fini del rilascio e l'uso dei suoi marchi di fabbrica GRABOVOI® e GRIGORI GRABOVOI®.
1.2. Da redovno i ažurno predaje izveštaje Davaocu naloga o svome tekućem radu i o rezultatima toga rada. Da za realizaciju ugovora o podlicenci snosi solidarnu odgovornost sa Davaocem naloga, koji nastupa kao Davalac podlicence, proporcionalnu isplata Primaocu naloga.	1.2. Di inviare regolarmente e tempestivamente i rapporti sul lavoro assegnato e sul risultato di lavoro svolto al Mandante. Al fine di attuare il Contratto di sub-licenza il Mandatario si impegna a recare la responsabilità solidale con il Mandante, il quale agisce in qualità di Concedente della sub- licenza, proporzionale ai pagamenti ricevuti dal Mandatario.
<b>2. PRAVA I OBAVEZE STRANA</b>	<b>2. DIRITTI E DOVERI DELLE PARTI</b>
2.1. Davalac naloga zadržava pravo da sklapa ugovore o nalogu sa trećim licima.	2.1. Il Mandante si riserva il diritto di stipulare i Contratti di ordini con i terzi.
2.2. Primalac naloga ima pravo da realizuje nalog koji mu je dat po ovom ugovoru na teritoriji zemalja Evropske Unije: Belgije, Federativne Republike Nemačke, Italije, Luksemburga, Holandije, Francuske, Velike Britanije, Danske, Irske, Grčke, Portugala, Španije, Austrije, Finske, Švedske, Mađarske, Kipra , Letonije, Latvije, Malte, Poljske, Slovačke, Slovenije, Češke, Estonije, Bugarske, Rumunije, Hrvatske, kao i Srbije, SAD, Južne Amerike, Indije, Japana, Kine i Australije.	2.2. Il Mandatario ha il diritto di svolgere i compiti assegnati a norma del presente Contratto nel territorio dell'Unione Europea: Belgio, La Repubblica Federale di Germania, Italia, Lussemburgo, Paesi Bassi, Francia, Gran Bretagna, Danimarca, Irlanda, Grecia, Portogallo, Spagna, Austria, Finlandia , Svezia, Ungheria, Cipro, Lettonia, Latvia, Malta, Polonia, Repubblica Slovacca, Slovenia, Repubblica Ceca, Estonia, Bulgaria, Romania, Croazia ed anche Serbia, Stati Uniti d'America, Sud America, India, Giappone, Cina e Australia.
2.3. Davalac naloga je obavezan da ako je to potrebno izda Primaocu naloga ovlašćenje za obavljanje radnji predviđenih tačkom 1.1 ovog ugovora.	2.3. Il Mandante è obbligato a, se necessario, rilasciare al Mandatario l'autorizzazione ad eseguire le azioni di cui al punto 1.1 del presente Contratto.
<b>3. CENA USLUGA I NAČIN ISPLATE</b>	<b>3. PREZZO DEL SERVIZIO E MODALITA' DI PAGAMENTO</b>
3.1. Naknada Primaoca naloga iznosi 10% , porez i doprinosi uključeni, prihoda Davaoca naloga od svih ugovora o podlicenci, realizovanih preko Primaoca naloga. Isplata naknade vrši se posle ispunjenja uslova ugovora o podlicenci.	3.1. Il compenso del Mandatario, le imposte e i contributi sono inclusi, ammonta à 10%, del fatturato del Mandante da ogni Contratto di sub- licenza realizzato tramite il Mandatario. Il pagamento del compenso è effettuato dopo l'adempimento delle condizioni del Contratto di sub-licenza.
<b>4. ROK VAŽENJA UGOVORA I NAČIN NJEGOVOG RASKIDA</b>	<b>4. LA DURATA DEL CONTRATTO E MODALITA' DI TERMINAZIONE</b>
4.1. Ovaj Ugovor stupa na snagu od momenta njegovog zaključivanja i važi tri godine.	4.1. Il presente Contratto entra in vigore dal momento della sua stipulazione, ed è valido per tre anni.
4.2. Ovaj ugovor može biti prevremeno raskinut prema zajedničkom sporazumu Strana, na zahtev jedne od Strana, ukoliko druga Strana suštinski prekrši ovaj ugovor i u drugim slučajevima, predviđenim važećim zakonima.	4.2. Questo Contratto può essere terminato prematuramente di comune accordo tra le Parti, su richiesta di una delle Parti, qualora l'altra parte violi in sostanza questo Contratto, e in altri casi, prescritti dalle leggi vigenti.
<b>5. ODGOVORNOST STRANA</b>	<b>5. RESPONSABILITA' DELLE PARTI</b>
5.1. Pitanja nastala tumačenjem i primenom ovog ugovora koja nisu regulisana ovim ugovorom regulišu se na osnovu važećih zakona.	5.1. I questioni derivanti dalla interpretazione e dall'applicazione del presente Contratto, che non sono disciplinati con esso, devono essere regolati in conformità alla legislazione vigente.
5.2. Prilikom promene podataka, sedišta, bankarskih rekvizita svaka od strana je obavezna da drugu stranu o tome obavesti.	5.2. In caso in cui si verificano le modifiche dei dati, delle sedi, dei dati bancari, ciascuna parte ha l'obbligo di avvisare l'altra parte della modifica.
5.3. Bila kakve izmene ili dopune uz ovaj ugovor smatraju se važećim ako su sačinjene u pismenoj formi i ako su ih	5.3. Le eventuali modifiche o l'integrazioni al presente Contratto devono essere considerate valide se presentate

potpisali ovlašćeni predstavnici Strana.	per iscritto e se sono firmate dai rappresentanti autorizzati delle Parti.
5.4. Uslovi ovog ugovora i dopunskih sporazuma uz njega predstavljaju poslovnu tajnu.	5.4. Le condizioni di questo Contratto e di eventuali accordi aggiuntivi rappresentano un segreto aziendale.
5.5. Posle potpisivanja ugovora sva prepiska i svi pregovori i sporazumi gube svoju pravnu snagu, ako u ovom ugovoru nema pozivanja na njih.	5.5. Dopo la firma del Contratto, tutta la corrispondenza e tutte le trattative e gli accordi perdono la loro forza di legge, se il Contratto non fa alcun riferimento ad esse.
5.6. Ugovor je sačinjen u dva primerka od kojih svaki ima jednaku pravnu snagu. Jedan primerak se nalazi kod Davaoca naloga, a drugi kod Primaoca naloga.	5.6. Il Contratto è redatto in due copie, ciascuna con la stessa forza legale. Una copia è conservata dal Mandante e l'altra dal Mandatario.
<b>6. ADRESE, REKVIZITI I POTPISI STRANA</b>	<b>6. INDIRIZZI, DARI E FIRME DELLE PARTI</b>
Davalac naloga:	Il Mandante:
Individualni preduzetnik Grigorii Grabovoi PR KONSALTING TECHNOLOGIES OF ETERNAL DEVELOPMENT	L'imprenditore Individuale Grigorii Grabovoi PR KONSALTING TECHNOLOGIES OF ETERNAL DEVELOPMENT
Adresa:	Indirizzo:
11102, Ulica Kneza Mihaila 21A, lok.113, Beograd, Srbija	11102, Ulica Kneza Mihaila 21A, loc.113, Belgrado, Serbia
E-mail: grigorii.grabovoi.pr@gmail.com	E-mail: grigorii.grabovoi.pr@gmail.com
Skype:	Skype:
Rekviziti banke:	Dati bancari:
_____	_____
_____	_____
_____	_____
_____	_____
Primalac naloga:	Il Mandatario:
_____	_____
_____	_____
_____	_____
Adresa:	Indirizzo:
_____	_____
_____	_____
_____	_____
E-mail:	E-mail:
Skype:	Skype:
Pasoš:	Passaporto:
_____	_____
_____	_____
Rekviziti banke:	Dati bancari:
_____	_____
_____	_____
_____	_____
_____	_____
<b>POTPISI STRANA:</b>	<b>FIRME DELLE PARTI:</b>
Davalac naloga:	Il Mandante:
_____ /Grigorii Grabovoi/	_____ /Grigorii Grabovoi/
Primalac naloga:	Il Mandatario:
_____ / _____ /	_____ / _____ /

Il dispositivo PRK-1UM e l'account Web individuale connesso 24 ore su 24 per testare e utilizzare il dispositivo per 90 minuti, possono essere utilizzati da persone che non sono incluse nell'elenco dei Sublicenziati. Tuttavia, è necessario presentare domanda per i partecipanti all'indirizzo e-mail [grigorii.grabovoi.pr@gmail.com](mailto:grigorii.grabovoi.pr@gmail.com), (copia della lettera all'indirizzo e-mail [grigorii.grabovoi.pr2@gmail.com](mailto:grigorii.grabovoi.pr2@gmail.com), 3 giorni prima del test.

È necessario fornire il nome completo del partecipante, la data di nascita e la data di svolgimento del test.

Puoi conoscere le condizioni finanziarie dei test di durata più lunga inviando una richiesta all'indirizzo e-mail: [grigorii.grabovoi.pr@gmail.com](mailto:grigorii.grabovoi.pr@gmail.com) È possibile condurre test fino a 8 minuti senza pagare.

I test a pagamento e gratuiti e l'utilizzo del dispositivo possono essere condotti allo scopo di fornire l'utilizzo del dispositivo da parte di altre persone, promuovere e concludere Accordi di Sublicenza per l'uso del Programma di istruzione con PRK-1UM.

**Fotocopie del brevetto "Metodo di prevenzione delle catastrofi e dispositivo per la sua realizzazione "e del brevetto" Sistema di trasporto delle informazioni"**





Informazioni dettagliate sui brevetti con la descrizione al sito:  
<https://licenzia8.wordpress.com/patents/>

# Brevetto "Il dispositivo dello sviluppo delle concentrazioni della vita eterna PRK-1U a tre modalità"



*United States of America*

*To Promote the Progress of Science and Useful Arts*

*The Director*

*of the United States Patent and Trademark Office has received an application for a patent for a new and useful invention. The title and description of the invention are enclosed. The requirements of law have been complied with, and it has been determined that a patent on the invention shall be granted under the law.*

*Therefore, this United States*

# *Patent*

grants to the person(s) having title to this patent the right to exclude others from making, using, offering for sale, or selling the invention throughout the United States of America or importing the invention into the United States of America, and if the invention is a process, of the right to exclude others from using, offering for sale or selling throughout the United States of America, products made by that process, for the term set forth in 35 U.S.C. 154(a)(2) or (c)(1), subject to the payment of maintenance fees as provided by 35 U.S.C. 41(b). See the Maintenance Fee Notice on the inside of the cover.

*Katherine Kelly Vidal*

DIRECTOR OF THE UNITED STATES PATENT AND TRADEMARK OFFICE

## **Maintenance Fee Notice**

If the application for this patent was filed on or after December 12, 1980, maintenance fees are due three years and six months, seven years and six months, and eleven years and six months after the date of this grant, or within a grace period of six months thereafter upon payment of a surcharge as provided by law. The amount, number and timing of the maintenance fees required may be changed by law or regulation. Unless payment of the applicable maintenance fee is received in the United States Patent and Trademark Office on or before the date the fee is due or within a grace period of six months thereafter, the patent will expire as of the end of such grace period.

## **Patent Term Notice**

If the application for this patent was filed on or after June 8, 1995, the term of this patent begins on the date on which this patent issues and ends twenty years from the filing date of the application or, if the application contains a specific reference to an earlier filed application or applications under 35 U.S.C. 120, 121, 365(c), or 386(c), twenty years from the filing date of the earliest such application (“the twenty-year term”), subject to the payment of maintenance fees as provided by 35 U.S.C. 41(b), and any extension as provided by 35 U.S.C. 154(b) or 156 or any disclaimer under 35 U.S.C. 253.

If this application was filed prior to June 8, 1995, the term of this patent begins on the date on which this patent issues and ends on the later of seventeen years from the date of the grant of this patent or the twenty-year term set forth above for patents resulting from applications filed on or after June 8, 1995, subject to the payment of maintenance fees as provided by 35 U.S.C. 41(b) and any extension as provided by 35 U.S.C. 156 or any disclaimer under 35 U.S.C. 253.



US012144599B2

(12) **United States Patent**  
**Grabovoi**

(10) **Patent No.:** **US 12,144,599 B2**  
(45) **Date of Patent:** **Nov. 19, 2024**

(54) **DEVICE OF DEVELOPMENT OF CONCENTRATIONS OF ETERNAL LIFE PRK-1U IS OF THREE-MODES**

(71) Applicant: **Grigorii Petrovich Grabovoi**, Belgrade (RS)

(72) Inventor: **Grigorii Petrovich Grabovoi**, Belgrade (RS)

(\* ) Notice: Subject to any disclaimer, the term of this patent is extended or adjusted under 35 U.S.C. 154(b) by 718 days.

(21) Appl. No.: **16/504,293**

(22) Filed: **Jul. 7, 2019**

(65) **Prior Publication Data**

US 2020/0008700 A1 Jan. 9, 2020

**Related U.S. Application Data**

(60) Provisional application No. 62/695,756, filed on Jul. 9, 2018.

(51) **Int. Cl.**

**A61B 5/05** (2021.01)

**A61B 5/00** (2006.01)

**A61M 21/00** (2006.01)

**G09B 19/00** (2006.01)

(52) **U.S. Cl.**

CPC ..... **A61B 5/05** (2013.01); **A61B 5/0059** (2013.01); **G09B 19/00** (2013.01); **A61M 21/00** (2013.01)

(58) **Field of Classification Search**

CPC ... A61B 5/05-055; A61B 5/168; A61B 5/486; A61B 5/4064; A61B 5/4854; A61B 5/242; A61M 21/00-02; A61M 2205/3303-3306; A61M 2205/583; A61M 2230/00

See application file for complete search history.

*Primary Examiner* — Thaddeus B Cox

(74) *Attorney, Agent, or Firm* — Georgiy L. Khayet

(57) **ABSTRACT**

Devices and methods for development of concentration are described herein. A three-mode device for development of concentration may include an optical sensing unit. The optical sensing unit may include a plurality of sensitive elements configured to sense a signal provided by a user. The signal may be associated with a plurality of electromagnetic fields. The plurality of sensitive elements may be configured to impose the plurality of electromagnetic fields onto each other to obtain an outgoing signal. The device may further include an optical emitting unit configured to emit the outgoing signal and one or more lenses for focusing concentration of the user. The one or more lenses may be associated with the optical sensing unit. The device may further include two switches for switching between a plurality of operation modes and a lighting unit to indicate each of the plurality of operation modes by emitting a predetermined light signal.

**15 Claims, 10 Drawing Sheets**

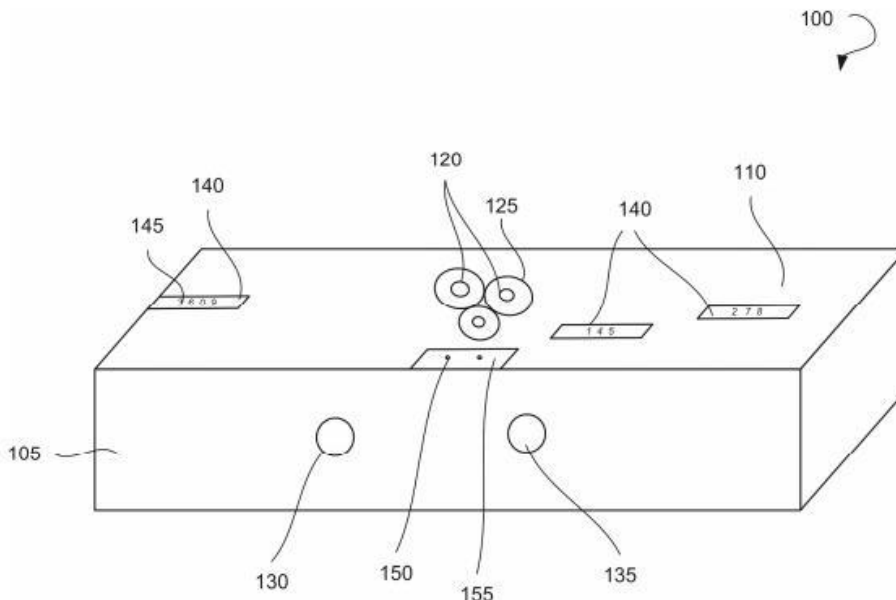



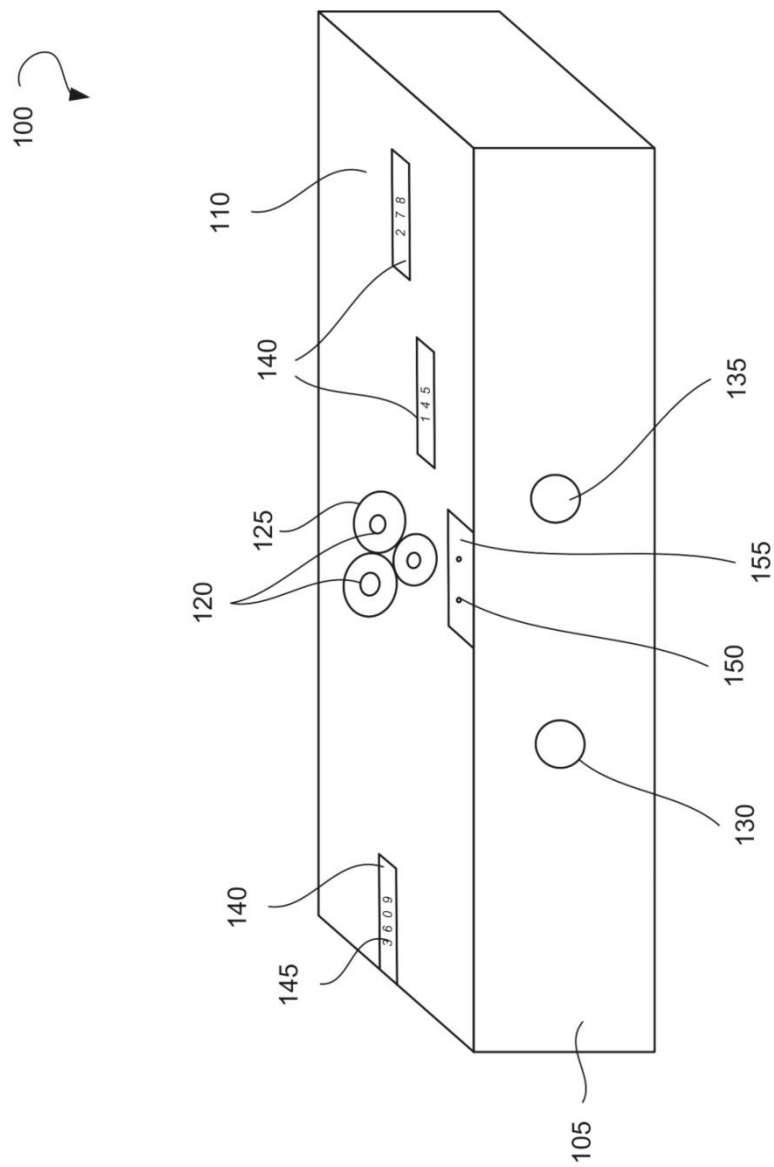

FIG. 1

200

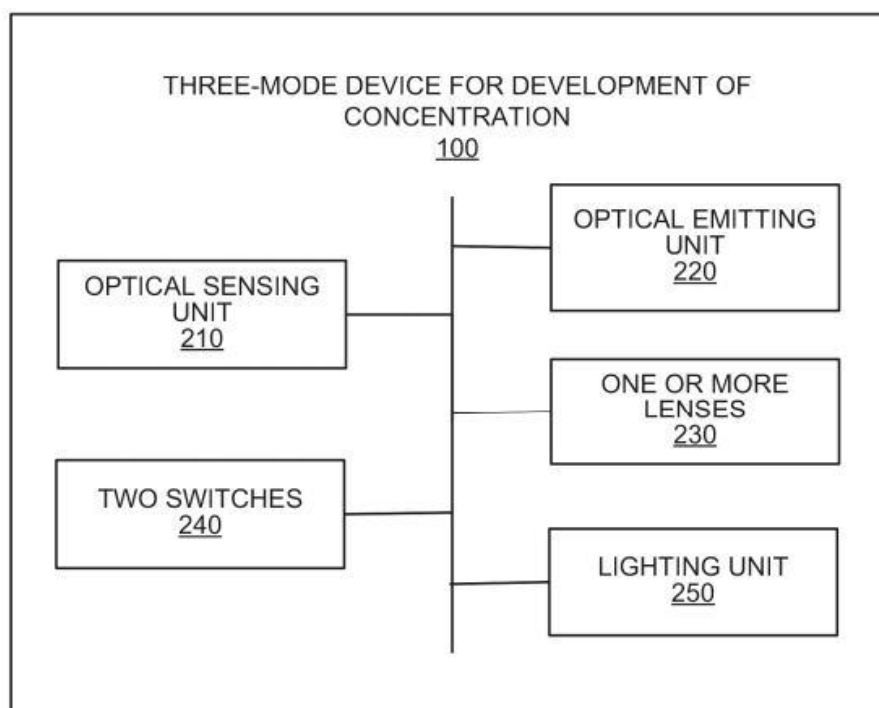

FIG. 2

300 ↗

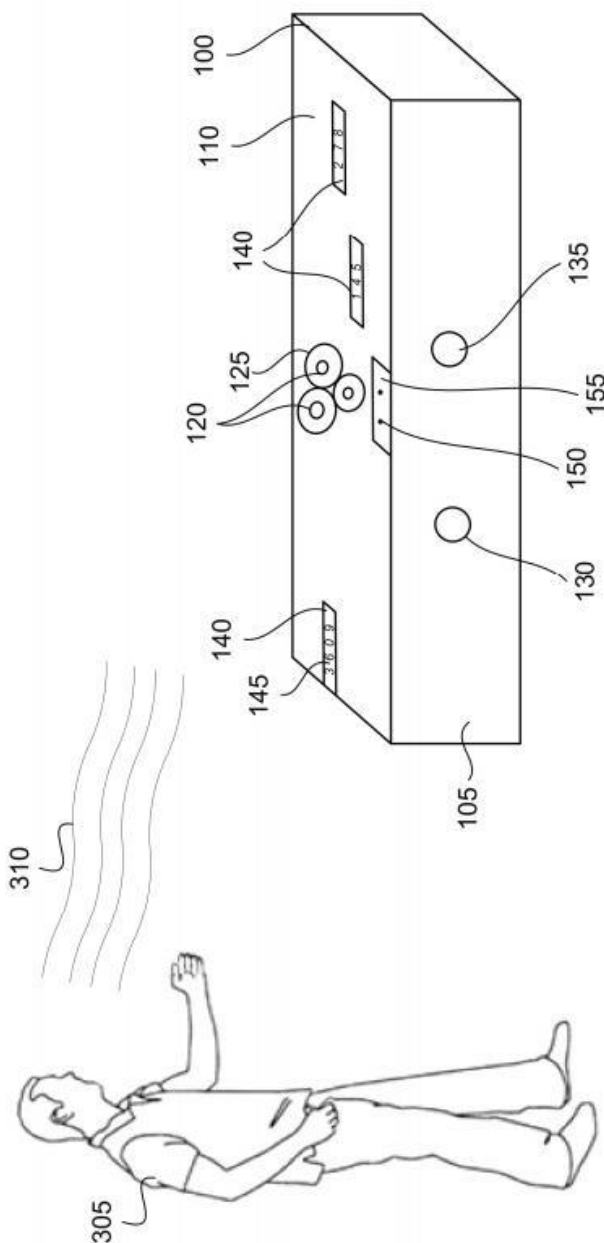

FIG. 3

400 ↷

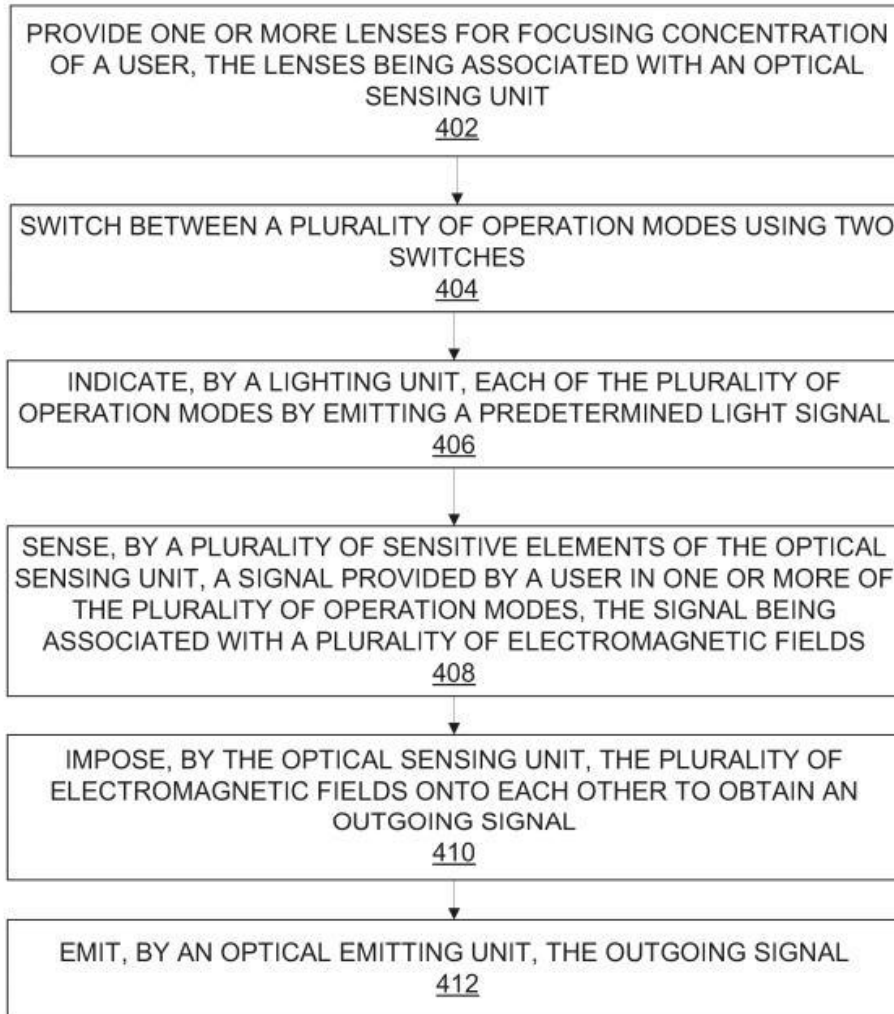
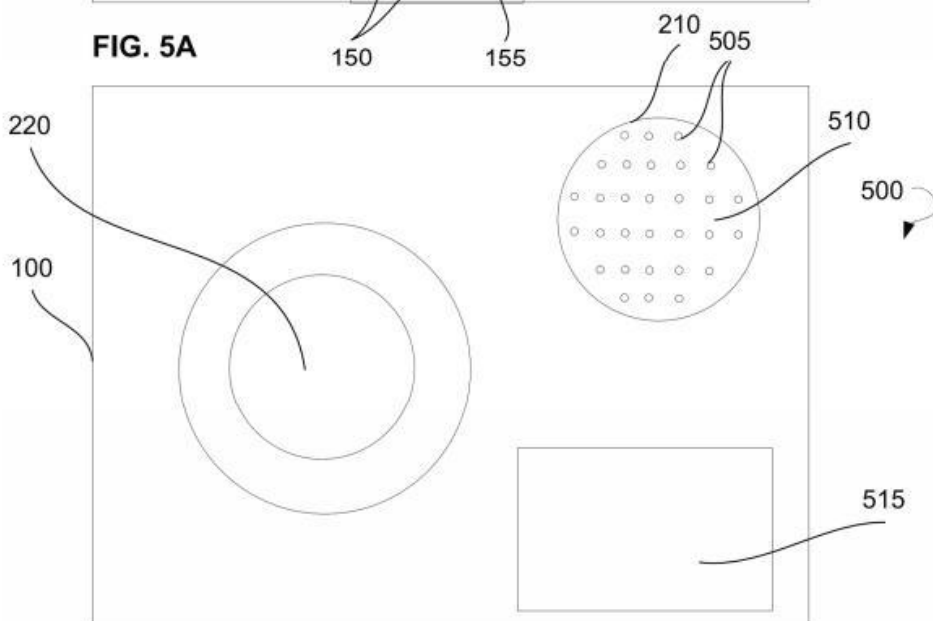
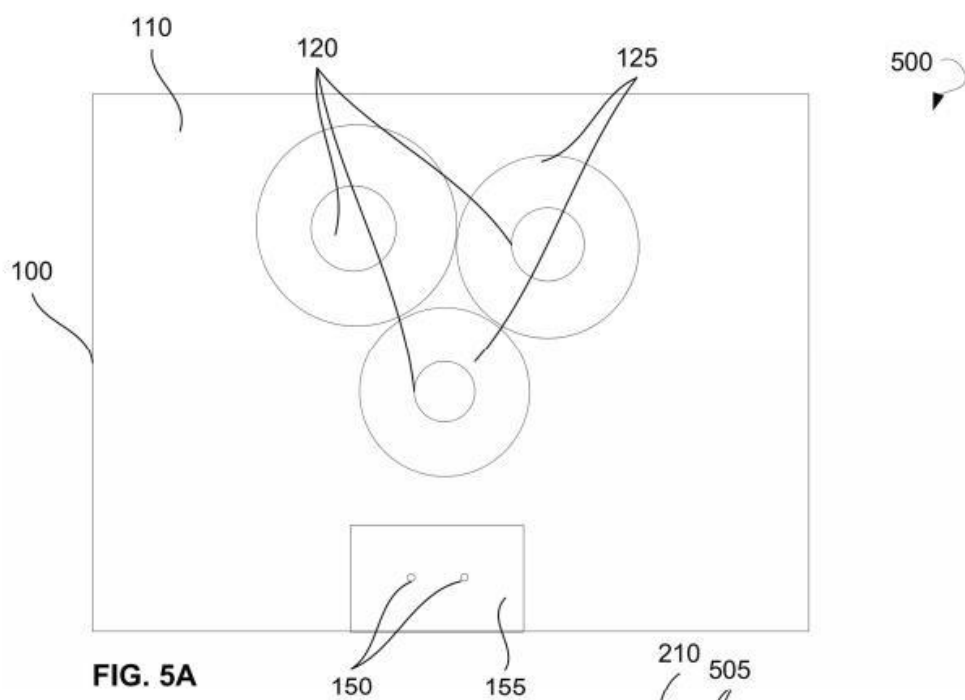
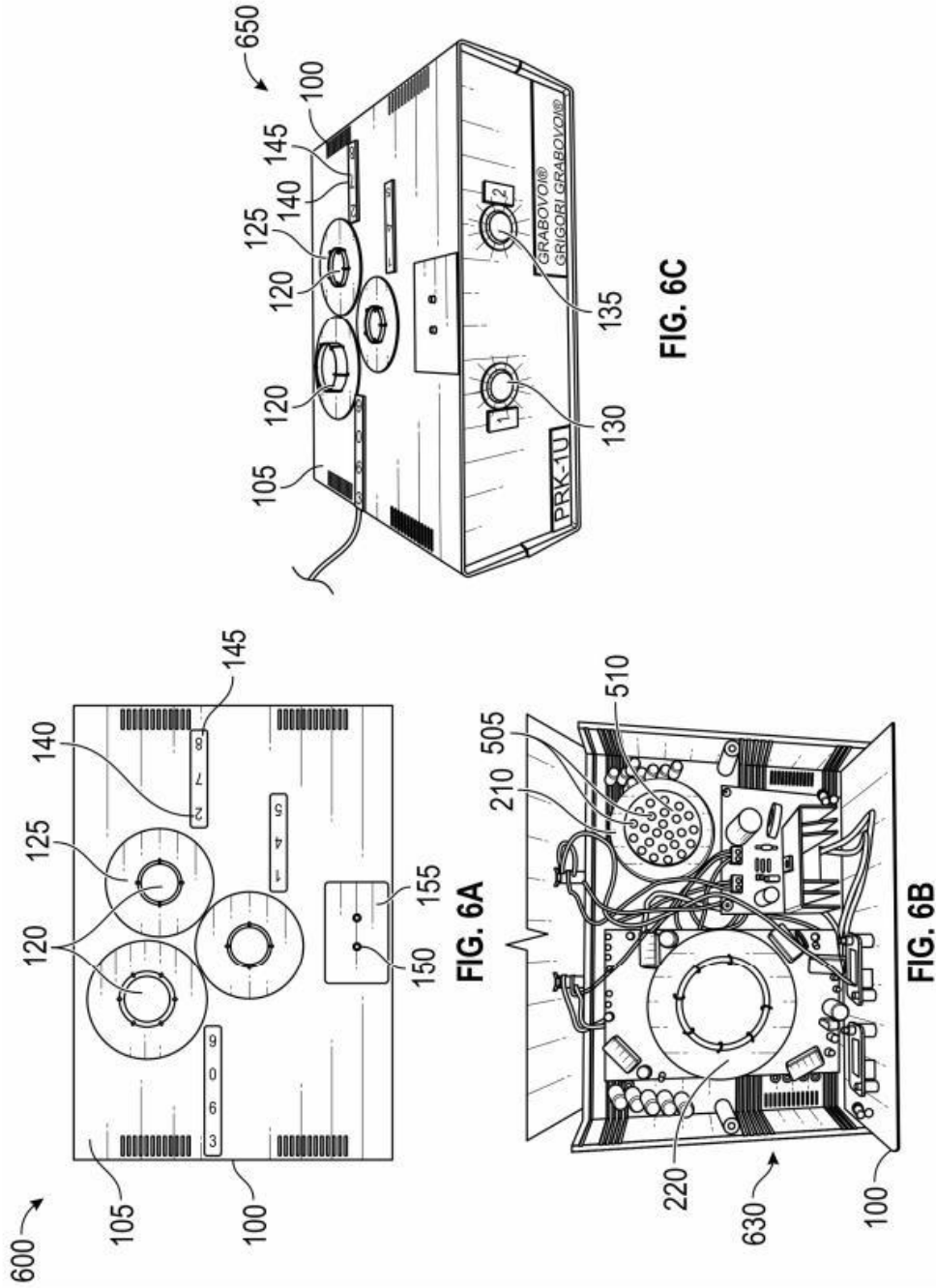

FIG. 4





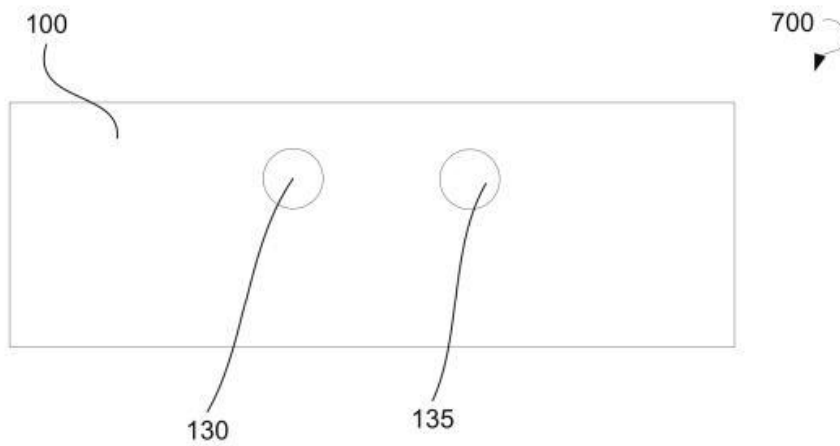

FIG. 7A

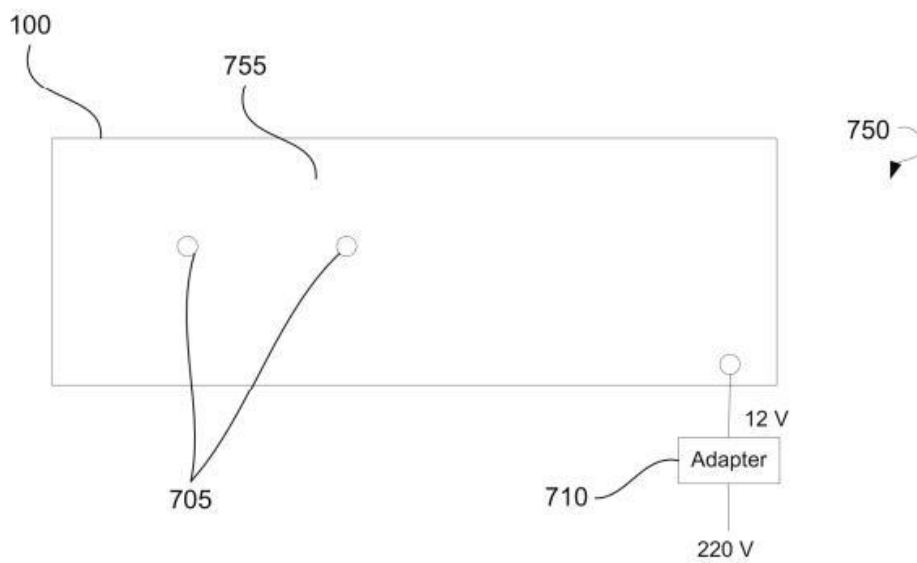

FIG. 7B

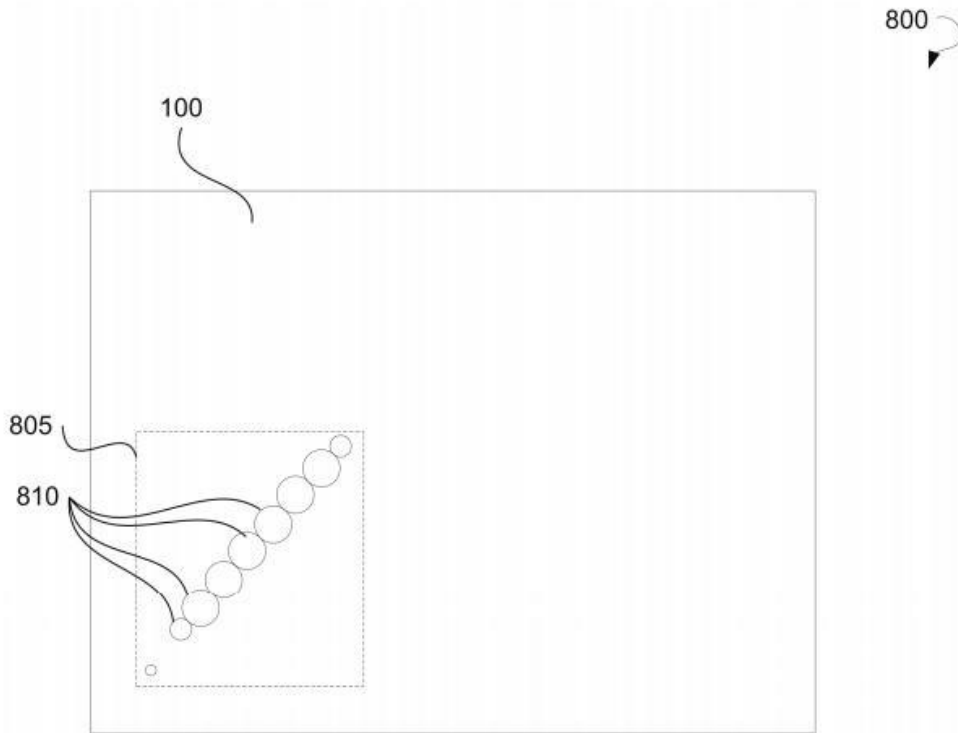

FIG. 8



900

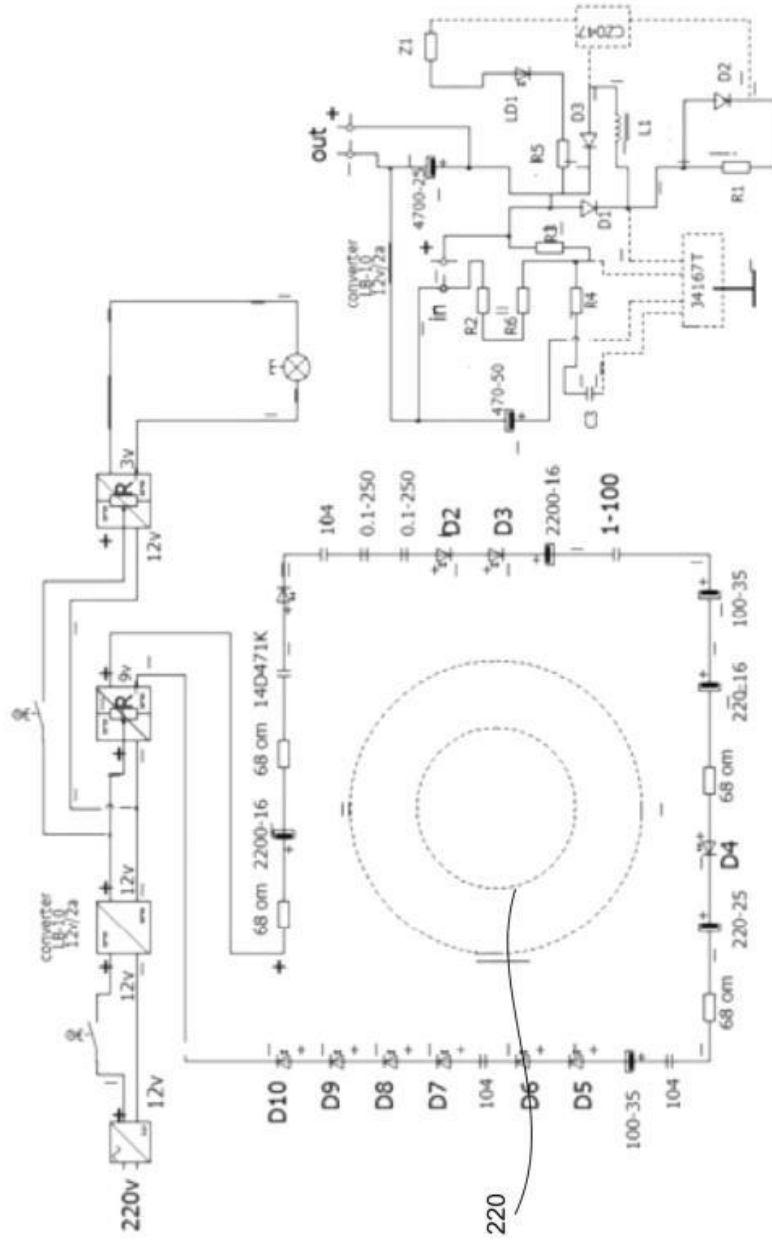

FIG. 9

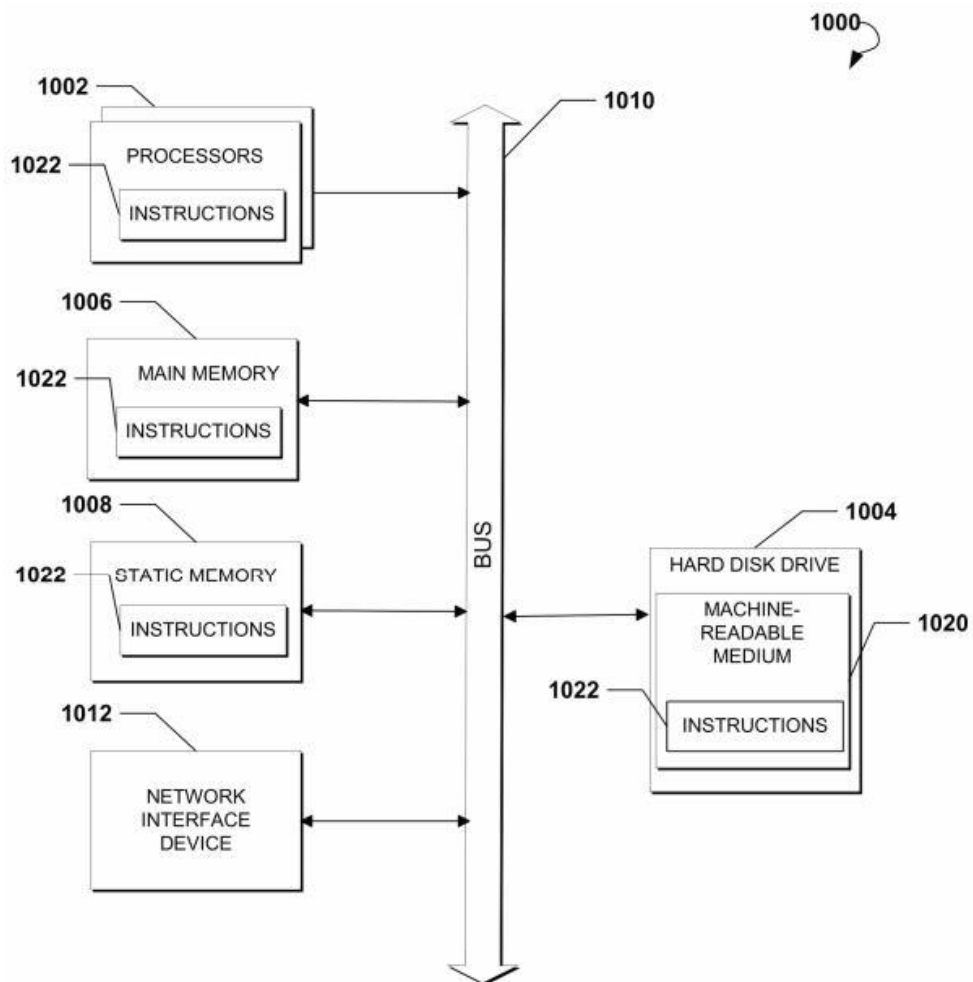

FIG. 10

1

**DEVICE OF DEVELOPMENT OF  
CONCENTRATIONS OF ETERNAL LIFE  
PRK-1U IS OF THREE-MODES**

CROSS-REFERENCE TO RELATED  
APPLICATIONS

This application claims priority of U.S. Provisional Patent Application No. 62/695,756 filed on Jul. 9, 2018, entitled "DEVICE OF DEVELOPMENT OF CONCENTRATIONS OF ETERNAL LIFE PRK-1U IS OF THREE-MODES," which is incorporated herein by reference in its entirety.

TECHNICAL FIELD

The present disclosure relates generally to optical devices and, more specifically, to a device for developing concentration.

BACKGROUND

The approaches described in this section could be pursued but are not necessarily approaches that have previously been conceived or pursued. Therefore, unless otherwise indicated, it should not be assumed that any of the approaches described in this section qualify as prior art merely by virtue of their inclusion in this section.

The variety of devices for sensing and/or determining physical and physiological parameters of a human body increases rapidly. However, the list of vital signs that may be sensed by such devices is mostly limited to a heart rate, blood pressure, blood oxygen level, blood sugar level, body temperature, and some other parameters. Meanwhile, it is generally known that cells of a human body, e.g., neurons, produce electrical activity. In particular, nerve impulses generated by neurons are electrical signals that create electromagnetic fields of the human body. Furthermore, some fluids of the human body are known to act as electrolytes and the flow of such fluids may generate fluctuating electromagnetic fields in the human body. However, conventional electromagnetic sensors are not intended for detecting the electromagnetic fields of the human body and are unable to transform electromagnetic signals emitted by the human body.

SUMMARY

This summary is provided to introduce a selection of concepts in a simplified form that are further described below in the Detailed Description. This summary is not intended to identify key features or essential features of the claimed subject matter, nor is it intended to be used as an aid in determining the scope of the claimed subject matter.

Provided are devices and methods for development of concentration. In some example embodiments, a three-mode device for development of concentration may include an optical sensing unit. The optical sensing unit may include a plurality of sensitive elements. The plurality of sensitive elements may be configured to sense, in one or more of a plurality of operation modes, a signal provided by a user. The signal may be associated with a plurality of electromagnetic fields. The plurality of sensitive elements may be configured to impose, based on the signal, the plurality of electromagnetic fields onto each other to obtain an outgoing signal. The three-mode device for development of concentration may further include an optical emitting unit configured to emit the outgoing signal and one or more lenses for

2

focusing concentration of the user. The one or more lenses may be associated with the optical sensing unit. The three-mode device for development of concentration may further include two switches for switching between the plurality of operation modes and a lighting unit to indicate each of the plurality of operation modes by emitting a predetermined light signal.

A method for development of concentration may commence with providing one or more lenses for focusing the concentration of a user. The one or more lenses may be associated with an optical sensing unit. The method may further include switching between a plurality of operation modes using two switches and indicating, by a lighting unit, each of the plurality of operation modes by emitting a predetermined light signal. The method may continue with sensing, by a plurality of sensitive elements of the optical sensing unit, in one or more of the plurality of operation modes, a signal provided by the user. The signal may be associated with a plurality of electromagnetic fields. The method may continue with imposing, by the optical sensing unit, based on the signal, the plurality of electromagnetic fields onto each other to obtain an outgoing signal. The method may further include emitting, by an optical emitting unit, the outgoing signal.

Additional objects, advantages, and novel features will be set forth in part in the detailed description section of this disclosure, which follows, and in part will become apparent to those skilled in the art upon examination of this specification and the accompanying drawings or may be learned by production or operation of the example embodiments. The objects and advantages of the concepts may be realized and attained by means of the methodologies, instrumentalities, and combinations particularly pointed out in the appended claims.

BRIEF DESCRIPTION OF THE DRAWINGS

Embodiments are illustrated by way of example and not limitation in the figures of the accompanying drawings, in which like references indicate similar elements and in which:

FIG. 1 illustrates a general perspective view of a three-mode device for development of concentration, in accordance with an example embodiment.

FIG. 2 is a block diagram showing various modules of a three-mode device for development of concentration, in accordance with an example embodiment.

FIG. 3 is a schematic diagram illustrating development of concentration of a user using a three-mode device for development of concentration, in accordance with an example embodiment.

FIG. 4 is a flow chart illustrating a method for development of concentration, in accordance with an example embodiment.

FIG. 5A is a schematic diagram illustrating a top view of a three-mode device for development of concentration when a cover is in a closed state, according to an example embodiment.

FIG. 5B is a schematic diagram illustrating a top view of a three-mode device for development of concentration when a cover is in an open state, according to an example embodiment.

FIG. 6A shows a top view of a three-mode device for development of concentration when a cover is in a closed state, according to an example embodiment

3

FIG. 6B shows a top view of a three-mode device for development of concentration when a cover is in an open state, according to an example embodiment.

FIG. 6C shows a general perspective view of a three-mode device for development of concentration, according to an example embodiment.

FIG. 7A shows a front view of a three-mode device for development of concentration, according to an example embodiment.

FIG. 7B is a rear view of a three-mode device for development of concentration, according to an example embodiment.

FIG. 8 shows a top view of a three-mode device for development of concentration, according to an example embodiment.

FIG. 9 is a schematic illustration showing elements of a three-mode device for development of concentration, according to an example embodiment.

FIG. 10 shows a computing system that can be used to implement a method for development of concentration, according to an example embodiment.

#### DETAILED DESCRIPTION

The following detailed description includes references to the accompanying drawings, which form a part of the detailed description. The drawings show illustrations in accordance with exemplary embodiments. These exemplary embodiments, which are also referred to herein as "examples," are described in enough detail to enable those skilled in the art to practice the present subject matter. The embodiments can be combined, other embodiments can be utilized, or structural, logical, and electrical changes can be made without departing from the scope of what is claimed. The following detailed description is, therefore, not to be taken in a limiting sense, and the scope is defined by the appended claims and their equivalents. In this document, the terms "a" and "an" are used, as is common in patent documents, to include one or more than one. In this document, the term "or" is used to refer to a nonexclusive "or," such that "A or B" includes "A but not B," "B but not A," and "A and B," unless otherwise indicated.

The present disclosure relates to methods and devices for development of concentration. Specifically, the development of concentration is provided by a three-mode device for development of concentration, also referred herein to as a three-mode device PRK-1U for development of concentration. The device may include an optical sensing unit configured to sense signals emitted by a user and an optical emitting unit configured to emit an outgoing signal. The device further includes lenses for focusing concentration of the user, switches for switching between operation modes, and a lighting unit to indicate a current operation mode by emitting a predetermined light signal. The device may further have one or more plates with numerical symbols for focusing the concentration of the user.

The device may include a housing in which elements of the device may be located. The housing may have a parallelepiped shape. The housing may be provided with a cover placed onto the housing to enclose the elements of the device inside the housing. The lenses and plates with numerical symbols for focusing concentration may be attached to an outer surface of the housing or to the cover. The user may be located in proximity to the device. The development of concentration of the user may be provided by focusing user attention on a receiver of the device and controlling the results of the concentration. The lenses and/or the plates

4

with numerical symbols may be configured to be the receiver of concentration of the user. To initiate development of concentration, the user may start concentrating on the lenses and/or the numerical symbols provided on the plates attached to the housing or the cover. Specifically, the user may focus user attention on the lenses and/or the numerical symbols and direct thoughts to the lenses and/or the numerical symbols of the device. The concentration of the user may include thoughts related to providing an eternal life, including concentration on being healthy, concentration on having the quality of control forecasting or control foresight, concentration on rejuvenation, concentration on a particular event in life, and so forth.

As known in psychology, the stronger a person concentrates on a goal, the events in the person's life are optimized and the goal is achieved faster. When concentrating, the user may perform the following actions. The user may imagine user consciousness as a sphere around the user's body informationally supported by the user's body itself. The further action of the user may include imagining that the sphere transforms into a shape similar to the shape of the user's body and then superimposes the shape onto the surface of the user's body. At the moment of superimposing, the user may imagine that the inner surface of the body-like shape comes into contact with the surface of the user's body and that the radiation from the outer's surface of this body-like shape spreads to all external infinite space relative to the user's body. The infinite space is considered to be the eternal reality connected with the organism of the user, which results in development of concentration on eternal life.

The devices and methods described herein are based on the principle of similarity. The principle of similarity is based on the theory of wave synthesis in combination with the unified reality theory (see Ph.D. Thesis in Physical and Mathematical Sciences, G. P. Grabovoi, "Research and Analysis of Fundamental Definitions of Optical Systems for Prediction of Industrial Nature Earthquakes and Disasters", Moscow, RAEN Publishing House, 1999, pp. 9-19; patent of the inventor No. RU 2148845C1 titled "Method of Prevention of Catastrophes and Equipment for its Realization"; and patent of the inventor No. RU 2163419C1 titled "Data Transmission System," which are incorporated herein by reference in their entirety). The devices and methods are further based on physical and mathematical theory, experimental results, physical and mathematical calculations, and the results of these calculations set forth in the publication titled "Research and Analysis of the Fundamental Definitions of Optical Systems in Disaster Prevention and Predictive Microprocessor Control", "Electronic Equipment, Series 3, Microelectronics", 1999, edition 1 (153), and other scientific materials.

In accordance with the wave synthesis theory, reality can be considered as a periodic intersection of stationary regions with dynamic regions, while in the intersection zones a synthesis of a dynamic wave and a stationary wave occurs. Any reality phenomenon can be defined in a form of optical systems. Human perception is performed using image-bearing elements of light that contain information. In case of transmitting information from a person generating information to be transmitted to an optical sensing element, the person may be considered to be a transmitting optical system. The transmitted information generated by thoughts of the person is received by an optical sensing unit to which the person directs the generated thought. As a thought is an electromagnetic wave, it can be transmitted as an element of an optical system. Sensitive elements of the optical sensing

5

unit preferably have the shape of a sphere, as the spherical shape of the sensitive element provides the maximum activation of the sensitive element due to internal reflection of signals. The collection of trial records and testimonies of use of the three-mode device PRK-1U for the development of the concentration is presented in the Appendix of Specification.

The three-mode device for development of concentration performs the imposition of fields from the generation of biological signals and electromagnetic fields (electromagnetic waves generated by the user) according to the principle of universal connection with control of the purpose of concentration. The device further develops concentration of creational control.

In the wave synthesis theory, it is known that a thought generated in a form of radiation simultaneously has two quantum states. The first state is located on a sensing element of a signal transmitter, and the second state is located on a signal receiver. Based on these principles, the device for interacting with thoughts to develop the concentration as described herein was created.

Referring now to the drawings, FIG. 1 is a general perspective view of a three-mode device 100 for development of concentration, hereinafter referred to as a device 100. The device 100 may include a housing 105 and a cover 110. In an example embodiment, the housing 100 may include a box of a rectangular shape. The device 100 may further include lenses 120. The lenses 120 may be attached to an outer surface of the cover 110. In an example embodiment, the lenses 120 may be made of glass. Each of the lenses 120 may be placed on a plate 125 (e.g., a metal plate). The diameter of the lenses 120 may be 20 mm, 25 mm, 60 mm, and any other diameter applicable for a particular embodiment of the device 100. The diameter of the plate 125 may be 60 mm, 64 mm, 70 mm, and any other diameter applicable for a particular embodiment of the device 100.

The device may further have a first switch 130 and a second switch 135 to switch between operation modes of the device 100. The device 100 may have one or more plates 140 with numerical symbols 145 depicted on the plates 140. The device 100 may further have one or more stones 150, such as diamonds, attached to the housing 105 or the cover 110 of the device 100. The stones may be placed on a plate 155. Further elements of the device 100 are shown in detail with reference to FIGS. 2-9.

FIG. 2 is a block diagram showing various units of a three-mode device 100 for development of concentration, in accordance with certain embodiments. Specifically, the device 100 may include an optical sensing unit 210, optical emitting unit 220, one or more lenses 230, two switches 240, and a lighting unit 250. The one or more lenses 230 for focusing concentration of a user may be associated with the optical sensing unit 210. The device 100 may further include a housing and a cover. The one or more lenses 230 may be disposed on the cover.

The optical sensing unit 210 may have a plurality of sensitive elements. In an example embodiment, the plurality of sensitive elements may be spherical. In an example embodiment, the sensitive elements may be made of glass. The plurality of sensitive elements may be configured to sense a signal provided by the user. The sensitive elements may sense the signal in one or more of a plurality of operation modes of the device 100. The signal may be associated with a plurality of electromagnetic fields. The signal provided by the user may be a biological signal. The biological signal may include an electromagnetic wave associated with thoughts generated by the user when con-

6

centrating on the one or more lenses 230 for focusing concentration. Specifically, the information (signal) may be generated in a form of electromagnetic radiation by the user. The user concentrates the electromagnetic radiation created by thought on the one or more lenses 230 located on the upper surface of the device 100.

The plurality of sensitive elements may be further configured to impose, based on the signal, the plurality of electromagnetic fields onto each other to obtain an outgoing signal. The optical emitting unit may be configured to emit the outgoing signal. In an example embodiment, the optical emitting unit 220 may include an optical lens. In an example embodiment, the optical lens may be made of glass. The optical emitting unit 220 may emit the outgoing signal in a form of at least an optical signal. In an example embodiment, the device 100 may include a further plurality of sensitive elements. The further plurality of sensitive elements may include crystals and stones, such as diamonds.

The two switches 240 may be used for switching between the plurality of operation modes of the device 100. The lighting unit 250 may be configured to indicate each of the plurality of operation modes of the device 100 by emitting a predetermined light signal. Specifically, the plurality of operation modes may include at least three modes. A first operation mode may be turned on by moving a first switch of the two switches 240 into an upward position. The first operation mode may be characterized by absence of emittance of a light signal by the lighting unit 250. A second operation mode may be turned on by moving a second switch of the two switches into an upward position. The second operation mode may be characterized by emittance of a static light signal by the lighting unit 250. A third operation mode may be turned on by moving the first switch into a downward position and further moving the first switch into an upward position while the second switch remains in the upward position. The third operation mode may be characterized by emittance of a repetitively-pulsed light signal by the lighting unit 250.

In an example embodiment, the two switches 240 may be made of a transparent or semi-transparent material, such as glass or plastics. The device 100 may have a light emitting diode (LED) disposed inside the housing for emitting the light signal. When the LED emits light inside the device 100, the light emitted from inside of the device 100 can be seen through the two switches 240. Upon switching between the operation modes, the LED may not emit light, may continuously emit light (i.e., provide the static light signal), and may repetitively emit light (i.e., provide the repetitively-pulsed light signal).

The signal provided by the user may be sensed in each of the operation modes. For example, the device 100 may be switched to the second operation mode and the optical sensing unit 210 may sense the signal provided by the user when the device 100 operates in the second operation mode. In an example embodiment, the device 100 may be switched to the third operation mode and the optical sensing unit 210 may sense the signal provided by the user when the device 100 operates in the third operation mode. The operation modes of the device 100 may be used to increase the concentration on the user.

In an example embodiment, the device 100 may further include a plurality of figures placed on the housing and/or the cover of the device 100. The figures may include numerical symbols for focusing the concentration of the user. The numerical symbols may be depicted on plates (e.g., metal, plastics, paper, wooden plates, etc.), which can be attached to the housing and/or the cover of the device 100.

The numerical symbols depicted on the plates may be used for focusing the concentration of the user.

In an example embodiment, the device 100 may further include a converting unit configured to convert the outgoing signal into an electrical signal. In an example embodiment, the converting unit may be connected to a processing unit. The processing unit may be in communication with the optical sensing unit 210, the optical emitting unit 220, and the lighting unit 250 and perform processing of sensed signals, imposed signals, optical signals, and outgoing signals. The device 100 may further include a power source in communication with the optical sensing unit 210, the optical emitting unit 220, and the lighting unit 250.

In the publication titled "Research and Analysis of the Fundamental Definitions of Optical Systems in Disaster Prevention and Predictive Microprocessor Control," "Electronic Equipment, Series 3, Microelectronics," 1999, edition 1 (153), the inventor proves the unified reality theory and the theory of wave synthesis. According to the unified reality theory and the theory of wave synthesis, the second operation mode results in applying the amplification of the stationary phase of the reality. Furthermore, according to the unified reality theory and the theory of wave synthesis, the third operation mode results in applying the amplification of the dynamic phase of reality.

The technique of providing eternal life can work according to the principle similar to principles of functioning of the human body in the field of thinking. According to the principle of functioning of the human body when creating thoughts, the physical body of a person consists of the same tissues that do not change in the process of thinking, but thoughts that are created in the physical body are different. In the three-mode device 100 for development of concentration, the similarity principle is applied, which is illustrated by the fact that the same two buttons (i.e., switches) are used to activate the third operation mode for amplification of the dynamic phase of the reality. In other words, no elements are added to the device 100 just as no elements are added to the human body when a new thought is created. The third operation mode is turned on by turning the first switch off and on (to the downward and upward position) again while the second switch remains in the upward position. Therefore, switching between three operation modes may be provided by two switches.

Thus, by using the unified reality theory and the theory of wave synthesis proved by physical and mathematical calculations and experiments, the components are selected and an electrical scheme is developed for the device 100 so that the device 100 is similar to a human body in the following sense. A human body generates thoughts without adding any matter (components) to the human body. Similarly, the device 100 autonomously, without adding further switches, i.e., in a closed system, generates the third operation mode for amplification of the dynamic phase of the reality, which is illustrated by the repetitively-pulsed light emittance. In other words, the element base of the device 100 has a self-development function similar to that in the human body. This function of the device 100, due to the interaction of the components of the device 100, itself includes the activation of the operation mode for repetitively-pulsed light emittance. This allows the development of concentration when using the device 100, as the preceding level of developing the concentration, including that achieved with the help of the device 100 itself, is always the starting point for further development of concentration.

The work with the device 100 in different operation modes provides extensive results on the development of

concentration, which is required in many areas of life, including production, operational activity, and other activities in industrial fields.

The device 100 may further be configured to activate an artificial intelligence function. This function enables the device 100, depending on the activity of generation of thoughts by the user and depending on the degree of development of concentration on eternal life in respect to specific events, to independently switch off the operation modes of the device 100 and then, after a time period determined by the device 100, again switch on any of three operation modes. Accordingly, the procedure of activation of this artificial intelligence function was developed.

The device 100 provides the capability to combine three modes of operation, thereby creating better concentration on ensuring eternal life.

FIG. 3 is a schematic diagram 300 illustrating development of concentration of a user using a three-mode device 100 for development of concentration, according to an example embodiment. A user 305 may be located in a proximity of the device 100. The user 305 may concentrate user attention on lenses 120 and/or numerical figures 145 of the device 100. The lenses 120 may have different diameters. By concentrating, the user 305 generates thoughts, which are electromagnetic signals 310. The thoughts may contain the purpose of concentration, such as concentration on eternal life, concentration on being healthy, concentration on having the quality of control forecasting or control foresight, concentration on rejuvenation, and so forth. The action of concentration for the current time and future time may be performed with respect to a sensing element of the optical emitting unit consisting of lenses. The user 305 may perform circular movements associated with the concentration (i.e., direct thoughts) by following a direction from a lens of a smaller diameter counterclockwise to lenses of a larger diameter. In the case of concentrations related to the current time and future time, a concentration beam may be directed in a direction from outside of the device 100 to an inner space of the device 100.

If the concentration of the user 305 relates to past events, the user 305 may perform circular movements associated with the concentration by following a direction from a lens of a smaller diameter clockwise to lenses of a larger diameter. The concentration beam may be directed in a direction from inside the device 100 to an outside space.

In accordance with the information transmission on the basis of the wave synthesis theory, another quantum state of thoughts may be projected on a signal receiver in a form of an optical emitting unit located inside the device 100.

FIG. 4 is a process flow diagram showing a method 400 for development of concentration, according to an example embodiment. In some embodiments, the operations may be combined, performed in parallel, or performed in a different order. The method 400 may also include additional or fewer operations than those illustrated.

The method 400 may commence with providing one or more lenses for focusing concentration of a user at operation 402. The lenses may be associated with an optical sensing unit. The method 400 may continue with switching between a plurality of operation modes using two switches at operation 404. Operation 406 of the method 400 may include indicating, by a lighting unit, each of the plurality of operation modes by emitting a predetermined light signal.

The method 400 may further include sensing, by a plurality of sensitive elements of the optical sensing unit, in one or more of the plurality of operation modes, a signal provided by the user at operation 408. The signal may be

associated with a plurality of electromagnetic fields. The plurality of sensitive elements may be spherical. The signal provided by the user may be a biological signal.

The method 400 may further include imposing, based on the signal, by the optical sensing unit, the plurality of electromagnetic fields onto each other to obtain an outgoing signal at operation 410. Specifically, the method 400 may be performed by using signal conditioning by imposing electromagnetic fields resulting from the generation of a biological signal to each other. The method 400 may be performed in accordance with the principle of universal connection with control of the purpose of concentration, which can be developed according to techniques described by the inventor in the publications mentioned herein.

The method 400 may further include emitting, by an optical emitting unit, the outgoing signal at operation 412. The optical emitting unit may include an optical lens. The optical emitting unit may emit the outgoing signal in the form of at least an optical signal. The method 400 may further include converting, by a converting unit, the outgoing signal into an electrical signal.

In an example embodiment, the method 400 may further include providing a power source. The power source may be in communication with the optical sensing unit and the optical emitting unit. In an example embodiment, the method 400 may further include providing a housing and a cover. The one or more lenses may be disposed on the cover.

FIG. 5A shows a top view 500 of a device 100 when a cover 100 is in a closed state, according to an example embodiment. The device 100 may have three plates 125 on which lenses 120 may be fastened. The plates 125 may be attached to the cover 120. The device 100 may further have a plate 155 for fastening stones 150, such as crystals or diamonds. The plate 155 may be attached to the cover 110.

FIG. 5B shows a top view 500 of the device 100 when the cover 100 is in an open state, according to an example embodiment. The device 100 may include an optical sensing unit 210, a plurality of sensitive elements 505, an optical emitting unit 220, a LED 510, and a converter 515. The plurality of sensitive elements 505 of the optical sensing unit 210 may sense the signal emitted by the user and provide the signal to the converter 515. The converter 515 may convert the signal into an electrical signal. The converter 515 may provide the electrical signal to the LED 510. The LED 510 may be electrically connected in parallel with other components of the device 100. Upon receipt of the electrical signal, the LED 510 may emit the electrical signal in the form of a light signal according to a current operation mode of the device 100.

The signal sensed by the plurality of sensitive elements 505 may be associated with a plurality of electromagnetic fields. The optical sensing unit 210 may impose the plurality of electromagnetic fields onto each other to obtain an outgoing signal. The optical sensing unit 210 may provide the outgoing signal to the optical emitting unit 220 for further emission of the outgoing signal by the optical emitting unit 220.

FIG. 6A shows a top view 600 of the device 100 when the cover is in a closed state, according to an example embodiment. The device 100 may have three plates 125 onto which lenses 120 may be fastened. The plates 125 may be attached to the cover. The device 100 may further have a plate 155 for fastening stones 150, such as crystals or diamonds. The plate 155 may be attached to the cover. The device 100 may have one or more plates 140 with numerical symbols 145 depicted on the plates 140.

In a further example embodiment, the device 100 may have concentration enhancement elements. The concentration enhancement elements may be used for enhancing and accelerating the development of concentration. The concentration enhancement elements may include crystals and stones 150, e.g., diamonds or rock crystals.

FIG. 6B shows a top view 630 of the device 100 when the cover is in an open state, according to an example embodiment. The device 100 may include an optical sensing unit 210, a plurality of sensitive elements 505, an optical emitting unit 220, and a LED 510.

FIG. 6C further shows a general perspective view 650 of the device 100, according to an example embodiment. The device 100 may include a first switch 130 and a second switch 135. The first switch 130 and the second switch 135 may be made of a transparent material, such as glass or plastic. When the LED 510 emits light inside the device 100, the light emitted from inside of the device 100 can be seen through the first switch 130 and the second switch 135.

In an example embodiment, figures may be placed on the cover in the form of numerical values 145. For example, figures 1, 4, 5 may be placed (e.g., written) near a smaller lens, and figures 2, 7, 8, and 9, 0, 6, 3 may be placed near larger lenses. The development of concentration using the presence of figures near the lenses can be made by concentrating on the lenses in a way described above and adding concentration on the figures.

FIG. 7A shows a front view 700 of the device 100, according to an example embodiment. The device 100 may have a first switch 130 and a second switch 135. Each of the first switch 130 and the second switch 135 may be configured to operate in several positions. Specifically, the first switch 130 may be moved into an upward position to switch to a first operation mode. The second switch 135 may be moved into an upward position to switch to a second operation mode. The first switch 130 may be moved into a downward position and further moved into the upward position to switch a third operation mode.

FIG. 7B shows a rear view 750 of the device 100, according to an example embodiment. The device 100 may have controlling elements 705 disposed in adjustment holes in the housing of the device 100 for tuning components of the device 100 using a side panel 755. The device 100 may be in communication with an adapter 710. The adapter 710 may be configured to convert the voltage of 220 V from a power grid into the voltage of 12 V consumed by the device 100.

FIG. 8 shows a top view 800 of the device 100, according to an example embodiment. The device 100 may further include one or more crystal systems 805. The crystal system 805 may consist of a plurality of crystals 810. The crystals 810 may be used for focusing the concentration of the user. The crystal system 805 may be a vertical crystal system in which the crystals 810 may have different radii and, hence, different heights. The radius of the crystals 810 may be 7 mm, 12 mm, and so forth.

In an example embodiment, the three-mode device for development of concentration may be used remotely through video monitoring of the device by a user, including via the Internet. The three-mode device for development of concentration is applicable in various areas related to providing eternal life, such as becoming healthy, developing the quality of control forecasting or control foresight, rejuvenating an organism, and so forth.

FIG. 9 is a schematic diagram 900 illustrating a three-mode device for development of concentration, according to an example embodiment. The elements shown on FIG. 9

may be located inside a housing of the three-mode device for development of concentration. The three-mode device for development of concentration may include an optical emitting unit 220.

Example 1 of operation of a three-mode device for development of concentration. On day 1, a first user turned the three-mode device off and then turned on after some period of time. Upon being turned on, the three-mode device entered the first operation mode, in which a red light mostly did not light up, meaning that power provided to the diode was low. Upon switching the three-mode device manually to the second and third operation modes, the three-mode device did not react, i.e., did not switch to the second and third operation modes.

The three-mode device is configured for developing concentrations on eternal life. The three-mode device can switch to one of the operation modes upon increasing the control load. In view of this, four users started a concentration session using the three-mode device by concentrating on lenses for focusing concentration of the users.

Three days later, the three-mode device entered the second operation mode. The three-mode device worked stably, but the third mode could not be turned on. Four users continued performing concentration sessions during the next three days. The three-mode device was placed in a room of the first user during the time when the concentration sessions were performed.

After three days, the second user took the three-mode device to work in a room of the second user. The three-mode device was moved to the room and turned on. The second user continued performing the concentration session using the three-mode device by concentrating on lenses for focusing concentration of the users. Upon turning on, the three-mode device began to self-adjust as was seen from diode heating. In a few seconds, the three-mode device entered the third operation mode and began to work stably in all three operation modes.

After three hours of operation, the three-mode device was again transferred to a room of the first user and turned on. The first user continued performing the concentration session using the three-mode device by concentrating on lenses for focusing concentration of the users. Upon turning on, the three-mode device worked in the third operation mode. At the time of turning on of the three-mode device, the first user was located in proximity to the three-mode device and had a conversation and was distracted from the concentration session. In a several minutes, the three-mode device automatically switched to the second operation mode. When the third operation mode was manually turned on, the device did not respond. Then, the three-mode device was unplugged and moved to the room of the second user, where it worked steadily before. Upon being turned on, the three-mode device immediately entered the third operation mode and there were no failures in operation of the three-mode device. The three-mode device worked stably in all three modes. After this check, the three-mode device was again transferred to the room of first user and turned on. The three-mode device did not work in the third operation mode in the room of the first user. Then, the operation of the three-mode device was re-tested in the room of the second user. The three-mode device was moved to the room of the second user and turned on. The three-mode device consistently entered all the three operation modes. The operation of the three-mode device was recorded by photographing the device. Each of the first user and the second user continued performing the concentration session using the three-mode device when the three-mode device was in the room of each

of the users. Then, the three-mode device was turned off, moved again to the room of the first user, and turned on. The first user continued the concentration session by concentrating on lenses of the three-mode device. Upon turning on, the three-mode device entered all the three operation modes and began to work stably in all operation modes.

Thus, the three-mode device independently switches to one of the operation modes in response to the signals received from the users during the concentration sessions. This function of artificial intelligence of the three-mode device, i.e. automatic switching between the modes, is turning on in case of simultaneous receipt of an increased amount of signals, e.g., from several users.

Example 2 of operation of a three-mode device for development of concentration. A user travelled to a foreign country and had a 24 hours long layover between the flights. The user experienced strong emotions during the layover, such as intensive fear, worry, lack of self-confidence, and perplexity. The user arrived at the hotel during the layover, turned the three-mode device, and started a first concentration session by concentrating on lenses of the three-mode device. Upon switching on, the three-mode device operated in the third operation mode and did not respond to manual switching of the three-mode device by the user to the second operation mode or the first operation mode. The next day, the user had a flight to the foreign country and an emotional state of the user stabilized, i.e. the user had a normal emotional state. When the user arrived at the hotel, the user turned the three-mode device and started a second concentration session by concentrating on lenses of the three-mode device. Upon switching on, the three-mode device operated in the first operation mode. The user manually switched the three-mode device to the second operation mode and then to the third operation mode. The three-mode device responded to switching between the modes by the user and switched to the second operation mode or the third operation mode, respectively. It was concluded that the user had intensive emotions and thoughts during the first concentration session. In view of this, the intensity of a signal transmitted by the user to the three-mode device caused automatic switching of the three-mode device to the third operation mode, in which the three-mode device amplified the dynamic phase of reality.

Example 3 of operation of a three-mode device for development of concentration. A user conducted concentration sessions using the three-mode device for four days in a first city. The three-mode device operated properly and responded to switching between the operation modes by the user by operating in a first operation mode, a second operation mode, or the third operation mode, respectively. On day five, the user moved to a second city and, upon arrival, started a concentration session. The user turned the three-mode device on. The three-mode device operated in the first operation mode. The user attempted to manually switch the three-mode device to the second operation mode. In response to the attempt of the user, the three-mode device switched to the third operation mode and did not respond to further attempts of the user to switch the three-mode device to the second operation mode. The automatic switching of the three-mode device to the third operation mode continued in the course of concentration sessions conducted by the user during seven days. During this seven-day period, the user had intensive emotions and thoughts when conducting the concentration sessions. In view of this, the intensity of a signal transmitted by the user to the three-mode device caused automatic switching of the three-mode device to the third operation mode, in which the three-mode device ampli-



fied the dynamic phase of reality. After seven days, the emotional state of the user stabilized and the three-mode device started operating normally and responded to manual switching of the three-mode device by the user to the second operation mode or the third operation mode.

FIG. 10 shows a diagrammatic representation of a computing device for a machine in the exemplary electronic form of a computer system 1000, within which a set of instructions for causing the machine to perform any one or more of the methodologies discussed herein can be executed. In various exemplary embodiments, the machine operates as a standalone device or can be connected (e.g., networked) to other machines. In a networked deployment, the machine can operate in the capacity of a server or a client machine in a server-client network environment, or as a peer machine in a peer-to-peer (or distributed) network environment. The machine can be a personal computer (PC), a tablet PC, a set-top box, a cellular telephone, a digital camera, a portable music player (e.g., a portable hard drive audio device, such as a Moving Picture Experts Group Audio Layer 3 (MP3) player), a web appliance, a network router, a switch, a bridge, or any machine capable of executing a set of instructions (sequential or otherwise) that specify actions to be taken by that machine. Further, while only a single machine is illustrated, the term "machine" shall also be taken to include any collection of machines that individually or jointly execute a set (or multiple sets) of instructions to perform any one or more of the methodologies discussed herein.

The computer system 1000 may include a processor or multiple processors 1002, a hard disk drive 1004, a main memory 1006 and a static memory 1008, which communicate with each other via a bus 1010. The computer system 1000 may also include a network interface device 1012. The hard disk drive 1004 may include a computer-readable medium 1020, which stores one or more sets of instructions 1022 embodying or utilized by any one or more of the methodologies or functions described herein. The instructions 1022 can also reside, completely or at least partially, within the main memory 1006 and/or within the processors 1002 during execution thereof by the computer system 1000. The main memory 1006 and the processors 1002 also constitute machine-readable media.

While the computer-readable medium 1020 is shown in an exemplary embodiment to be a single medium, the term "computer-readable medium" should be taken to include a single medium or multiple media (e.g., a centralized or distributed database, and/or associated caches and servers) that store the one or more sets of instructions. The term "computer-readable medium" shall also be taken to include any medium that is capable of storing, encoding, or carrying a set of instructions for execution by the machine and that causes the machine to perform any one or more of the methodologies of the present application, or that is capable of storing, encoding, or carrying data structures utilized by or associated with such a set of instructions. The term "computer-readable medium" shall accordingly be taken to include, but not be limited to, solid-state memories, optical and magnetic media. Such media can also include, without limitation, hard disks, floppy disks, NAND or NOR flash memory, digital video disks, Random Access Memory, Read-Only Memory, and the like.

The example embodiments described herein may be implemented in an operating environment comprising software installed on a computer, in hardware, or in a combination of software and hardware.

Thus, three-mode devices and methods for development of concentration are described. Although embodiments have been described with reference to specific exemplary embodiments, it will be evident that various modifications and changes can be made to these exemplary embodiments without departing from the broader spirit and scope of the present application. Accordingly, the specification and drawings are to be regarded in an illustrative rather than a restrictive sense.

What is claimed is:

1. A three-mode device for development of concentration, the device comprising:
  - a housing;
  - a first optical unit disposed in the housing, the first optical unit comprising a plurality of spherical elements;
  - a second optical unit disposed in the housing wherein the second optical unit includes an optical lens;
  - one or more lenses for enabling a user to affix a user gaze on the one or more lenses;
  - one or more plates attached to the housing, wherein the one or more lenses are placed on the one or more plates, wherein a diameter of the one or more plates exceeds a diameter of the one or more lenses;
  - two switches for switching between a plurality of operation modes associated with emittance of a predetermined light signal, the two switches being disposed on the housing; and
  - a lighting unit disposed in the housing and configured to indicate each of the plurality of operation modes by emitting the predetermined light signal.
2. The device of claim 1, further comprising a cover.
3. The device of claim 2, further comprising a plurality of figures placed on one of the housing and the cover, wherein the plurality of figures includes numerical symbols.
4. The device of claim 2, wherein the one or more lenses are disposed on the cover.
5. The device of claim 1, further comprising a power source in communication with the lighting unit.
6. The device of claim 1, wherein the plurality of operation modes includes:
  - a first operation mode configured to be turned on by moving a first switch of the two switches into an upward position, the first operation mode being characterized by absence of emittance of a light signal by the lighting unit;
  - a second operation mode configured to be turned on by moving a second switch of the two switches into an upward position, the second operation mode being characterized by emittance of a static light signal by the lighting unit; and
  - a third operation mode configured to be turned on by moving the first switch into a downward position and further moving the first switch into the upward position, the third operation mode being characterized by emittance of a repetitively-pulsed light signal by the lighting unit.
7. The device of claim 1, wherein the plurality of spherical elements are made of glass.
8. The device of claim 1, wherein the optical lens is made of glass.
9. The device of claim 1, further comprising a further plurality of optical elements, wherein the further plurality of optical elements are selected from crystals and stones.
10. A method for development of concentration, the method comprising:
  - providing a housing;

15

providing a first optical unit disposed in the housing, the first optical unit comprising a plurality of spherical elements;

providing a second optical unit disposed in the housing, wherein the second optical unit includes an optical lens;

providing one or more lenses for enabling a user to affix a user gaze on the one or more lenses;

providing one or more plates, wherein the one or more lenses are placed on the one or more plates, wherein a diameter of the one or more plates exceeds a diameter of the one or more lenses;

switching between a plurality of operation modes using two switches disposed on the housing, the plurality of operation modes being associated with emittance of a predetermined light signal; and

indicating, by a lighting unit disposed in the housing, each of the plurality of operation modes by emitting the predetermined light signal.

11. The method of claim 10, further comprising providing a power source, wherein the power source is in communication with the lighting unit.

12. The method of claim 10, further comprising providing a cover.

13. The method of claim 12, further comprising providing a plurality of figures, wherein the plurality of figures includes numerical symbols placed on one of the housing and the cover.

14. The method of claim 12, wherein the one or more lenses are disposed on the cover.

15. A three-mode device for development of concentration, the device comprising:

a housing;

a first optical unit disposed in the housing, the first optical unit comprising a plurality of optical elements, wherein the plurality of optical elements are made of glass;

16

a second optical unit disposed in the housing, wherein the second optical unit includes an optical lens;

one or more lenses for enabling a user to affix a user gaze on the one or more lenses, the one or more lenses being made of glass;

one or more plates attached to the housing, wherein the one or more lenses are placed on the one or more plates, wherein a diameter of the one or more plates exceeds a diameter of the one or more lenses;

two switches for switching between a plurality of operation modes associated with emittance of a predetermined light signal, the two switches being disposed on the housing; and

a lighting unit disposed in the housing and configured to indicate each of the plurality of operation modes by emitting the predetermined light signal, wherein the plurality of operation modes includes:

a first operation mode configured to be turned on by moving a first switch of the two switches into an upward position, the first operation mode being characterized by absence of emittance of a light signal by the lighting unit;

a second operation mode configured to be turned on by moving a second switch of the two switches into an upward position, the second operation mode being characterized by emittance of a static light signal by the lighting unit; and

a third operation mode configured to be turned on by moving the first switch into a downward position and further moving the first switch into the upward position, the third operation mode being characterized by emittance of a repetitively-pulsed light signal by the lighting unit.

\* \* \* \* \*

# Certificati di registrazione della progettazione industriale del dispositivo PRK-1UM

## In Gran Bretagna (Intellectual Property Office)



Intellectual  
Property  
Office

### Certificate of Registration for a UK Design

Design number: 6406099

Grant date: 30 November 2024

Registration date: 20 November 2024

#### This is to certify that,

in pursuance of and subject to the provision of Registered Designs Act 1949, the design of which a representation or specimen is attached, had been registered as of the date of registration shown above in the name of

Grigorii Petrovich Grabovoi

in respect of the application of such design to:

smart projectors

International Design Classification:

Version: 14-2023

Class: 16 PHOTOGRAPHIC, CINEMATOGRAPHIC AND OPTICAL APPARATUS

Subclass: 02 PROJECTORS AND VIEWERS

A handwritten signature in blue ink that reads "Adam Williams".

#### Adam Williams

Comptroller-General of Patents, Designs and Trade Marks

Intellectual Property Office

The attention of the Proprietor(s) is drawn to the important notes overleaf.



Intellectual Property Office is an operating name of the Patent Office

[www.gov.uk/ipo](http://www.gov.uk/ipo)

Representation of Designs







Intellectual Property Office is an operating name of the Patent Office

[www.gov.uk/ipo](http://www.gov.uk/ipo)

# In Belgio, Paesi Bassi, Lussemburgo (Benelux (BOIP))

2024-06-11 13:27

Search or retrieve a design



## Copy of the Designs Register

### Registration number

90582-01

### Number, date and hour of application

90582-01 10-06-2024, 10.31

### Date of registration

11-06-2024

### Expiration date

10-06-2029

### Name and address of the holder

Grigorii Petrovich Grabovoi

Ulica Kneza Mihaila 21A, lok.113

11102 Belgrad

Serbia

### Representative or postal address of holder

Fenix Legal KB

Östermalmstorg 1,3tr

11442 Stockholm

Sweden

### Reproduction of design

SEE REPRODUCTION(S)

### Indication of a product followed by the class(es) and subclass(es)

Smart projectors (cl 16-02).

### Indication of the creator of the design

Grigorii Petrovich GRABOVOI

### Date of publication of registration

11-06-2024

### Status

Registered



# In Svizzera (Istituto Federale della Proprietà Intellettuale)



Eidgenössisches Institut für Geistiges Eigentum  
Institut Federal de la Propriete Intellectuelle  
Istituto Federale della Proprietà Intellettuale  
Swiss Federal Institute of Intellectual Property

Stauffacherstrasse 65/59 g  
CH-3003 Bern  
T +41 31 377 77 77  
info@ipi.ch | www.ige.ch

## Swissregauszug - Designs

Stand vom 24.12.2024

Designnummer	148367
Gesuchsnummer	2024-00556
Hinterlegungsdatum	21.11.2024
Eintragungsdatum	23.12.2024
Publikationsdatum	23.12.2024
Schutzperiode bezahlt bis	21.11.2029
Maximale Schutzdauer	21.11.2049

---

### Intelligente Projektoren

---

#### Inhaber/in

Grigorij Petrovich Grabovoi  
Ulica Kneza Mihaila 21A, lok.113  
11102 Belgrad  
Serbien

#### Designer/in

Grigorij Petrovich Grabovoi  
11102 Belgrad  
Serbien

#### Bezeichnung

Intelligente Projektoren

#### Locarno Klassifikation

16-02

#### Hinterlegungsart

Einzelhinterlegung

#### Anzahl Hinterlegungen

1

#### Hinterlegungen

Reproduktion

#### Ordnungsnummern

1

#### Prioritäten

BX 90582-01 10.06.2024

1/3

02.01.2025

148367



Designbilder

Ordnungsnummer: 1



Abbildung Nr.: 1/6



Abbildung Nr.: 2/6



Abbildung Nr.: 3/6



Abbildung Nr.: 4/6



Abbildung Nr.: 5/6



Abbildung Nr.: 6/6

## Historie

23.12.2024

### Eintragung

Veröffentlicht in Swissreg am 23.12.2024

### Schutztitelstadium

Eingetragen

### Designnummer

148367

### Eintragungsdatum

23.12.2024

### Publikationsdatum

23.12.2024

### Schutztitelstadium

~~Gesuch~~

### Designnummer

### Eintragungsdatum

### Publikationsdatum

 Bundesrepublik Deutschland 

# Urkunde

über die Eintragung des  
Designs Nr. 402024100406-0001



Darstellung 1 von 6

**Inhaber/Inhaberin:**  
Grigorii Petrovich Grabovoi, Belgrad, RO

**Tag der Anmeldung:**  
10.06.2024

**Tag der Eintragung:**  
12.11.2024

Die Präsidentin des Deutschen Patent- und Markenamts



Eva Schewior

München, 12.11.2024



Die Voraussetzungen der Schutzzfähigkeit werden bei der Eintragung eines Designs nicht geprüft.  
Den aktuellen Rechtsstand und Schutzzumfang entnehmen Sie bitte dem DPMAregister unter [www.dpma.de](http://www.dpma.de).



# Auskunft zum Design 402024100406-0001

Stand am 13.01.2025

---

Es bestehen folgende Eintragungen:

---

## Stammdaten

---

- [19] **Datenbestand:** DE  
[----] **Bestandsart:** Aktiv  
[----] **Designnummer:** 402024100406-0001  
[21] **Aktenzeichen:** 402024100406.6  
[11] **Registernummer:** 402024100406  
[----] **Designzustand:** Design eingetragen  
[----] **Aufschiebungsstatus:** Keine Aufschiebung  
[22] **Anmeldetag:** 10.06.2024  
[15] **Eintragungstag:** 12.11.2024  
[----] **Veröffentlichungsdatum:** 06.12.2024  
[54] **Erzeugnis(se):** Intelligente Projektoren [Smart Projectors]  
[51] **Klasse(n):** 16-02  
[----] **Klassenversion:** 14  
[----] **Zahl der Darstellungen:** 6  
[73] **Inhaber:** Grigorii Petrovich Grabovoi, Belgrad, RO  
[72] **Entwerfer:** Grigorii Petrovich Grabovoi, Belgrad, RO  
[----] **Bewirkte Schutzdauer:** 5 Jahre  
[----] **Fälligkeit:** 30.06.2029
-

[-----] **Zahlungsfrist:** 31.12.2029

[-----] **Erstmalige Übernahme in DPMRegister:** 13.11.2024

[-----] **Tag der (letzten) Aktualisierung in DPMRegister:** 13.11.2024; 06.12.2024

## Verfahrensdaten

---

Eintragung

[-----] **Verfahrensart:** Eintragung

[-----] **Verfahrensstand:** Das Design wurde eingetragen

[-----] **Verfahrensstandtag:** 12.11.2024

[-----] **Heftnummer:** 49

[-----] **Heftteil:** Teil 1a

[-----] **Heftjahr:** 2024

[45] **Veröffentlichungsdatum:** 06.12.2024

## Design-Darstellungen

---

**402024100406-0001.1**



**402024100406-0001.2**



**402024100406-0001.3**



**402024100406-0001.4**



**402024100406-0001.5**



**402024100406-0001.6**



# In Giappone (Japan Patent Office)



## 意匠登録証 (CERTIFICATE OF DESIGN REGISTRATION)

登録第 1790930 号  
(REGISTRATION NUMBER)

意匠に係る物品等  
(ARTICLE, etc. TO WHICH THE DESIGN IS APPLIED)

プロジェクター

意匠権者  
(OWNER OF THE DESIGN RIGHT)

セルビア国, 11102 ベオグラード, ウリ  
ツァ クネザ ミハイラ 21エー, ロク. 1  
13  
国籍・地域 ロシア連邦

グリゴリー ペトロヴィッチ グラボ  
ヴォイ

意匠の創作を  
した者  
(CREATOR OF THE DESIGN)

グリゴリー ペトロヴィッチ グラボ  
ヴォイ

出願番号  
(APPLICATION NUMBER)

意願 2024-024362

出願日  
(FILING DATE)

令和 6年 11月 26日 (November 26, 2024)

登録日  
(REGISTRATION DATE)

令和 7年 1月 31日 (January 31, 2025)

この意匠は、登録するものと確定し、意匠原簿に登録されたことを証する。

(THIS IS TO CERTIFY THAT THE DESIGN IS REGISTERED ON THE REGISTER OF THE JAPAN PATENT OFFICE.)

令和 7年 1月 31日 (January 31, 2025)

特許庁長官  
(COMMISSIONER, JAPAN PATENT OFFICE)

小野洋太





# CERTIFICATE OF DESIGN REGISTRATION

REGISTRATION NUMBER 1790930

ARTICLE TO WHICH THE  
DESIGN IS APPLIED: Projector

OWNER OF  
THE DESIGN RIGHT: Ulica Kneza Mihaila 21A, lok.113  
Belgrad, 11102, Republic of Serbia  
Nationality: Russian Federation  
Grigorii Petrovich Grabovoi

CREATOR OF THE DESIGN: Grigorii Petrovich Grabovoi

APPLICATION NUMBER: 2024-024362  
FILING DATE: November 26, 2024  
REGISTRATION DATE: January 31, 2025

THIS IS TO CERTIFY THAT THE DESIGN IS REGISTERED ON THE  
REGISTER OF THE JAPAN PATENT OFFICE.

January 31, 2025

COMMISSIONER, JAPAN PATENT OFFICE

Yota ONO (Official Stamp)

(19) 【発行国】日本国特許庁 (JP)  
(45) 【発行日】令和7年2月10日 (2025. 2. 10)  
(12) 【公報種別】意匠公報 (S)  
(11) 【登録番号】意匠登録第1790930号 (D1790930)  
(24) 【登録日】令和7年1月31日 (2025. 1. 31)  
(54) 【意匠に係る物品】プロジェクター  
(52) 【意匠分類】H7-61  
(51) 【国際意匠分類】Loc (14) Cl. 16-02  
【Dターム】H7-61VZB  
(21) 【出願番号】意願2024-24362 (D2024-24362)  
(22) 【出願日】令和6年11月26日 (2024. 11. 26)  
(31) 【優先権主張番号】90582-01  
(32) 【優先日】令和6年6月10日 (2024. 6. 10)  
(33) 【優先権主張国・地域又は機関】ベネルクス商標意匠庁 (BX)  
(72) 【創作者】  
【氏名】グリゴリー ペトロヴィッチ グラボヴォイ  
【住所又は居所】セルビア国, 11102 ベオグラード, ウリツァ クネザ ミハイラ 21エー, ロク. 113  
(73) 【意匠権者】  
【識別番号】524435270  
【氏名又は名称】グリゴリー ペトロヴィッチ グラボヴォイ  
【氏名又は名称原語表記】Grigorii Petrovich Grabovoi  
【住所又は居所】セルビア国, 11102 ベオグラード, ウリツァ クネザ ミハイラ 21エー, ロク. 113  
【住所又は居所原語表記】Ulica Kneza Mihaila 21A, lok. 113, 11102 Belgrad, Serbia  
(74) 【代理人】  
【識別番号】110003487  
【氏名又は名称】弁理士法人東海特許事務所  
【審査官】坂田 麻智  
【図面】  
【正面やや上方から見た斜視図】



②)

意匠公報 1 7 9 0 9 3 0

【正面側やや左上から見た斜視図】



【正面側左上から見た斜視図】



(3)

意匠公報 1 7 9 0 9 3 0

【正面側右上から見た斜視図】



【右側面やや上方から見た斜視図】



(4)

意匠公報 1 7 9 0 9 3 0

【左側面やや上方から見た斜視図】



## Fotocopie dei marchi

Le opere, i dispositivi e le attività svolte da Grigori Grabovoi sono protetti da marchi:

Dell'Unione europea "GRABOVOI®" con numero di registrazione n. 009414673 del 18 febbraio 2011 (data di deposito 30 settembre 2010) e dell'Unione europea "GRIGORI GRABOVOI®" con numero di registrazione n. 009414632 del 18 febbraio 2011 (data di deposito settembre 30, 2010). I dati su questi marchi sono forniti sul sito ufficiale dell'Ufficio per l'armonizzazione nel mercato interno dell'Unione europea che registra i marchi <http://oami.europa.eu/ows/rw/pages/index.en.do>. Indirizzo: Avenida de Europa, 4-03008 Alicante SPAGNA, Telefono + 3496 5139100; Email: [information@oami.europa.eu](mailto:information@oami.europa.eu)

The image shows a certificate of registration for a Community Trade Mark. The background features a map of Europe with the EU flag's stars. At the top left is the logo of the Harmonization Office, a blue 'R' inside a circle of yellow stars. The text is in German and English. The German text includes 'HABM – HARMONISIERUNGSAMT FÜR DEN BINNENMARKT', 'EINTRAGUNGSRURKUNDE', and 'OHIM – OFFICE FOR HARMONIZATION IN THE INTERNAL MARKET'. The English text includes 'CERTIFICATE OF REGISTRATION'. The registered mark 'GRIGORI GRABOVOI' is displayed in a white box. The registration date is '18/02/2011' and the number is '009414632'. The certificate is signed by António Campinos, the President of the Office.

**HABM – HARMONISIERUNGSAMT FÜR DEN BINNENMARKT**  
MARKEN, MUSTER UND MODELLE

**EINTRAGUNGSRURKUNDE**

Diese Eintragungsurkunde wird für die unten angegebene Gemeinschaftsmarke ausgestellt. Die betreffenden Angaben sind in das Register für Gemeinschaftsmarken eingetragen worden.

**OHIM – OFFICE FOR HARMONIZATION IN THE INTERNAL MARKET**  
TRADE MARKS AND DESIGNS

**CERTIFICATE OF REGISTRATION**

This Certificate of Registration is hereby issued for the Community Trade Mark identified below. The corresponding entries have been recorded in the Register of Community Trade Marks.

Eingetragen / Registered 18/02/2011

No 009414632

GRIGORI GRABOVOI

Der Präsident / The President

*António Campinos*

António Campinos



Dell'Australia "GRABOVOI®" con numero di registrazione n. 1477713 del 02 luglio 2012 (data di deposito del 01 marzo 2012) e "GRIGORI GRABOVOI®" con numero di registrazione n. 1477714 del 02 luglio 2012 (la data di deposito di marzo 01, 2012). I dati relativi a questi marchi sono forniti sul sito ufficiale dell'Ufficio di proprietà intellettuale Australia (Proprietà intellettuale Australia): <http://www.ipaustralia.gov.au> Indirizzo: The Canberra Central Office, Ground Floor, Discovery House, 47 Bowes Street , Phillip ACT 2606; e-mail: [assist@ipaustralia.gov.au](mailto:assist@ipaustralia.gov.au)



**Australian Government**

**IP Australia**

Discovery House Phillip ACT 2606  
PO Box 200, Woden ACT 2606  
Australia  
Phone: 1300 651 010  
International Callers: +61-2 6283 2999  
Facsimile: +61-2 6283 7999  
Email: [assist@ipaustalia.gov.au](mailto:assist@ipaustalia.gov.au)  
Website: [www.ipaustalia.gov.au](http://www.ipaustalia.gov.au)

21/03/2012

International Bureau, WIPO  
34, chemin des Colombettes  
P.O. Box 18  
1211 Geneva 20,  
SWITZERLAND

**MADRID AGREEMENT AND PROTOCOL  
COMPLETION OF EX OFFICIO EXAMINATION  
- INTERIM STATUS OF A MARK -  
Rule 18BIS(1) (a) and (b)**

RE: International Registration No. 1106610 / Trade Mark No. 1477713  
For the mark: (Words) GRABOVOI  
Holder of the international registration:  
Grigori Grabovoi

The above International Registration Designating Australia has been accepted for protection for the following goods/services:

Class: 9

Apparatus for recording, transmission or reproduction of sound or images; magnetic data carriers, recording discs; automatic vending machines and mechanisms for coin-operated apparatus; cash registers, calculating machines, data processing equipment and computers; fire-extinguishing apparatus; data-processing programs; recorded and unrecorded data carriers of all kinds, in particular CDs, MDs, DVDs, video tapes and audio cassettes

Class: 16

Paper, cardboard and goods made from these materials, not included in other classes; printed matter; bookbinding material; photographs; stationery; adhesives for stationery or household purposes; artists' materials; paint brushes; typewriters and office machines (except furniture); instructional and teaching material (except apparatus)

Class: 41

Holistic medical coaching, providing electronic publications (non-downloadable); presentation of live performances, academies (education), education and instruction, correspondence courses,



---

**IPA**Australia • Patents • Trade Marks • Designs • Plant Breeder's Rights

ABN 38 113 072 755



arranging and conducting of cultural and sports events, providing of training; arranging and conducting of conferences, arranging and conducting of congresses, arranging and conducting of symposiums, coaching, vocational guidance, arranging and conducting of seminars, arranging and conducting of workshops (providing of training), arranging and conducting of colloquiums, arranging of exhibitions for cultural or educational purposes, entertainment; sporting and cultural activities; translation; conducting public readings and live performances (entertainment); services of a publishing firm, except printing; providing recreation facilities; providing games on the Internet; editing of texts (except publicity texts); film, video tape film, audio and television film production for all media; rental of film, video tape film, audio and television film productions on media of all kinds, editorial services, namely proof-reading of books and periodicals; correspondence courses

Class: 44

Medical services; holistic medical services in the fields of naturopathy and alternative medicine; acupuncture services, bioresonance therapy; psycho-mental services to influence and create emotional balance; mental healing; meditative and non-meditative physical and mental exercises being a guide to accessing self-healing powers for therapeutic purposes; healing counselling, medical and psycho-mental life counselling; consultancy with regard to holistic medical matters

If a Notification of Provisional Refusal has been issued in relation to this IRDA, the protection may not apply to all of the goods and/or services originally claimed.

Once a trade mark is accepted, it must be advertised in our Official Journal of Trade Marks. Your trade mark will be advertised on 22/03/2012.

Within 3 months after advertisement (the opposition period), other people may oppose protection of your trade mark. If no one has opposed the protection of your trade mark, or seeks an extension of time, by the end of the opposition period, your trade mark will be protected.

If notice of opposition is filed you will be notified, and in order to receive further documentation relating to the opposition, you will need to supply an address for service in Australia.

Registrar of Trade Marks  
IP Australia

Del Giappone "GRABOVOI®" con numero di registrazione n. 1106610 del 14 febbraio 2013 (la data di deposito della domanda 01.03.2012 anno) e "GRIGORI GRABOVOI®" ha un numero di registrazione n. 1106611 del 14 febbraio 2013 (la data di deposito della domanda 01.03.2012). I dati su questi marchi sono forniti sul sito ufficiale della biblioteca digitale di proprietà industriale (IPDL) degli uffici brevetti del Giappone [http://www.ipdl.inpit.go.jp/homepg\\_e.ipdl](http://www.ipdl.inpit.go.jp/homepg_e.ipdl) Indirizzo ufficio brevetti giapponese: 3-4 -3 Kasumigaseki, Chiyoda-ku, Tokyo 100-8915, Giappone E-mail: [PA1B00@jpo.go.jp](mailto:PA1B00@jpo.go.jp)



商標登録証  
(CERTIFICATE OF TRADEMARK REGISTRATION)

国際登録第1106611号  
(INTERNATIONAL REGISTRATION NUMBER)

商標  
(THE MARK)

GRIGORI GRABOVOI

指定商品又は指定役務並びに商品及び役務の区分  
(LIST OF GOODS AND SERVICES)

9 Apparatus for recording, transmission or reproduction of sound or images; magnetic data carriers, recording discs; automatic vending machines and mechanisms for coin-operated apparatus; cash registers, calculating  
その他別紙記載 (REFER TO THE ATTACHED SHEET)

商標権者  
(OWNER OF THE TRADEMARK RIGHT)

Grigori Grabovoi  
Kanalstr. 43 22085 Hamburg  
(Germany)

国際登録日  
(INTERNATIONAL REGISTRATION DATE)

01.04.2011

登録日  
(REGISTRATION DATE)

平成25年 4月 5日 (April 5, 2013)

この商標は、登録するものと確定し、商標原簿に登録されたことを証する。  
(THIS IS TO CERTIFY THAT THE TRADEMARK IS REGISTERED ON THE REGISTER OF THE JAPAN PATENT OFFICE.)

平成25年 4月 5日 (April 5, 2013)

特許庁長官  
(COMMISSIONER, JAPAN PATENT OFFICE)

深野弘行



# 商標登録証

(続葉 1)

(CERTIFICATE OF TRADEMARK REGISTRATION)

国際登録第1106611号 (INTERNATIONAL REGISTRATION NUMBER)

指定商品又は指定役務並びに商品及び役務の区分

(LIST OF GOODS AND SERVICES)

- ( 9) machines, data processing equipment and computers; fire-extinguishing apparatus; data-processing programs; recorded and unrecorded data carriers of all kinds, in particular CDs, MDs, DVDs, video tapes and audio cassettes.
- 16 Paper, boxes of paper, table cloths of paper, table napkins of paper, cardboard and cardboard articles; printed matter; bookbinding material; photographs; stationery; adhesives for stationery or household purposes; artists' materials; paint brushes; instructional and teaching material (except apparatus).
- 41 Holistic medical coaching, providing electronic publications (non-downloadable); presentation of live performances, academies (education), education and instruction, correspondence courses, arranging and conducting of cultural and sports events, providing of training; arranging and conducting of conferences, arranging and conducting of congresses, arranging and conducting of symposiums, professional training and coaching services; vocational guidance, arranging and conducting of seminars, arranging and conducting of workshops (providing of training), arranging and conducting of colloquiums, arranging of exhibitions for cultural or educational purposes, entertainment; sporting activities; organization of exhibitions for cultural or educational purposes; conducting public readings and live performances (entertainment); services of a publishing firm, except printing; providing recreation facilities; providing games on the Internet; editing of texts (except publicity texts); film, video tape film, audio and television film production for all media; editorial services, namely proof-reading of books and periodicals; correspondence courses.
- 44 Medical services; holistic medical services in the fields of naturopathy and alternative medicine; acupuncture services, psycho-mental services to influence and create emotional balance; mental healing; healing counselling, medical and psycho-mental life counselling; consultancy with regard to holistic medical matters.

[以下余白]

Della Cina (Repubblica popolare cinese). "GRABOVOI®" ha un numero di registrazione № G1106610 del 01 ottobre 2012 (la data di deposito della domanda 01.03.2012) e "GRIGORI GRABOVOI®" ha un numero di registrazione G1106611 del 01 ottobre 2012 (la data di deposito di l'applicazione 01.03.2012). I dati relativi a questi marchi sono forniti sul sito web ufficiale dell'Ufficio di Stato della proprietà intellettuale della Repubblica popolare cinese (SIPO) <http://sbcx.saic.gov.cn/traide/> Codice postale: 100028 Casella postale: No.100088 cassetta postale , 104 branch, Beijing, China E-mail: [chinatrademarkdatabase@gmail.com](mailto:chinatrademarkdatabase@gmail.com) Indirizzo: Room 213, No. 14 Shuguangxili, Chaoyang, Beijing, China.

STATEMENT OF GRANT OF PROTECTION

Rule 18ter(1) of the Common Regulations

<p>I. Office sending the statement:</p> <p>Trademark Office State Administration for Industry and Commerce People's Republic of China</p> <p>Sanlihe Donglu 8, Xicheng District Beijing 100820, China Tel: 8610-88650662 Fax: 8610-68050285</p>
<p>II. Number of the international registration: 1106611</p> <p>This statement is related to the above international registration notified on <u>03/01/2012</u> by WIPO.</p>
<p>III. Name of the holder: GRIGORI GRABOVOI</p>
<p>IV. Protection is granted to the mark that is the subject of this international registration for all the goods and/or all the services requested.</p>
<p>V. Signature or official seal of the Office sending the statement:</p> <div style="text-align: center;">  </div>
<p>VI. Date on which the statement was sent: 10/01/2012</p>

**STATEMENT OF GRANT OF PROTECTION**

**Rule 18ter(1) of the Common Regulations**

I. Office sending the statement:  Trademark Office State Administration for Industry and Commerce People's Republic of China	Sanlihe Donglu 8, Xicheng District Beijing 100820, China Tel: 8610-88650662 Fax: 8610-68050285
II. Number of the international registration: 1106610 This statement is related to the above international registration notified on <u>03/01/2012</u> by WIPO.	
III. Name of the holder: GRIGORI GRABOVOI	
IV. Protection is granted to the mark that is the subject of this international registration for all the goods and/or all the services requested.	
V. Signature or official seal of the Office sending the statement:  	
VI. Date on which the statement was sent: 10/01/2012	

Degli Stati Uniti d'America. «GRABOVOI®» ha un numero di registrazione n. 4329566 del 30 aprile 2013 (data di deposito 02 marzo 2011) e “GRIGORI GRABOVOI®” ha un numero di registrazione 85255853 del 19 luglio 2013 (data di deposito 02 marzo 2011) . I dati su questi marchi sono forniti sul sito Web ufficiale dell'ufficio brevetti e marchi degli Stati Uniti / Stati Uniti Ufficio brevetti e marchi che registra i marchi <http://www.uspto.gov> Indirizzo: P.O. Box 1450, Alexandria, VA 22313-1450, Telefono 1-800-786-9199; Email: [TrademarkAssistanceCenter@uspto.gov](mailto:TrademarkAssistanceCenter@uspto.gov)

**United States of America**  
United States Patent and Trademark Office

# Grabovoi

**Reg. No. 4,329,566** GRABOVOI, GRIGORI PETROVICH (RUSSIAN FED. INDIVIDUAL)

**Registered Apr. 30, 2013** MOSCOW, RUSSIAN FED.

**Int. Cl.: 41**

**SERVICE MARK**

**SUPPLEMENTAL REGISTER**

FOR: PROFESSIONAL COACHING SERVICES IN THE FIELD OF HOLISTIC MEDICINE, MENTAL AND SPIRITUAL TECHNOLOGIES; EDUCATION SERVICES, NAMELY, PROVIDING EDUCATIONAL WORKSHOPS AT ACADEMIES, AND PROVIDING CLASSES AND APPRENTICESHIPS, ALL IN THE FIELD OF HOLISTIC MEDICINE, MENTAL AND SPIRITUAL TECHNOLOGIES; EDUCATION IN THE FIELDS OF HOLISTIC MEDICINE, MENTAL AND SPIRITUAL TECHNOLOGIES RENDERED THROUGH CORRESPONDENCE COURSES, ORGANIZING ARRANGING AND CONDUCTING LECTURES, LIVE EDUCATION SEMINARS AND COACHING IN THE FIELD OF HOLISTIC MEDICINE, CONDUCTING WORKSHOPS AND SEMINARS IN THE FIELD OF HOLISTIC MEDICINE, MENTAL AND SPIRITUAL TECHNOLOGIES; PUBLISHING OF ELECTRONIC PUBLICATIONS, IN CLASS 41 (U.S. CLS. 100, 101 AND 107).

FIRST USE 7-1-2012; IN COMMERCE 7-1-2012.

THE MARK CONSISTS OF STANDARD CHARACTERS WITHOUT CLAIM TO ANY PARTICULAR FONT, STYLE, SIZE, OR COLOR.

THE NAME(S), PORTRAIT(S), AND/OR SIGNATURE(S) SHOWN IN THE MARK IDENTIFIES GRIGORI PETROVICH "GRABOVOI", WHOSE CONSENT(S) TO REGISTER IS MADE OF RECORD.

SER. NO. 85-255,787, FILED PR. 3-2-2011; AM. S.R. 7-12-2012.

VERNA BETH RIRIE, EXAMINING ATTORNEY



*Liana Stewart Esq.*  
Acting Director of the United States Patent and Trademark Office

# Certificato dei "Laboratori Idvorsky" di conformità del dispositivo PRK-1UM alle Norme sulla compatibilità elettromagnetica

Idvorski laboratorije d.o.o. Beograd  
Volgina 15, 11060 Beograd  
tel: +381 11 6776329  
[www.idvorsky.com](http://www.idvorsky.com)  
[office@idvorsky.com](mailto:office@idvorsky.com)  
Sertifikaciono telo



**SERTIFIKAT O PREGLEDU TIP A broj 00093 01518**

prema **Pravilniku o elektromagnetskoj kompatibilnosti** (Sl. glasnik RS br. 25/2016 i 21/2020)

DATUM IZDAVANJA: 07.10.2024. VAŽI DO: 06.10.2027.

PODNOŠILAC ZAHTEVA: Preduzetnik Grigorij Grabovoi PR  
KONSALTING TECHNOLOGIES OF ETERNAL DEVELOPMENT  
Kneza Mihaila 21A lokal 113, 11102 Beograd

NAZIV / VRSTA APARATA: Uređaj za razvoj koncentracija večnog života PRK-1UM tri-mod

ROBNA MARKA: GRABOVOI ®  
GRIGORI GRABOVOI ®

PROIZVOĐAČ: Preduzetnik Grigorij Grabovoi PR  
KONSALTING TECHNOLOGIES OF ETERNAL DEVELOPMENT  
Kneza Mihaila 21A lokal 113, 11102 Beograd

TIP / MODEL: **PRK-1UM tri-mod**



## Opis aparata (proizvoda), namena i tehnički podaci:

Uređaj za razvoj koncentracija (**ne smatra se medicinskim uređajem**).

### Tehnički podaci:

Nominalni napon: 5 V DC  
Nominalna struja: 0,4 A  
Dimenzije: 200 mm x 160 mm x 65 mm  
Masa: 1 kg

## Izveštaji sa ispitivanja

Primenjeni standardi:	Broj izveštaja:	Izdat od:	Datum:
SRPS EN IEC 55014-1:2021 SRPS EN IEC 55014-2:2021 SRPS EN IEC 61000-3-2:2019 + A1:2021 SRPS EN 61000-3-3:2014 + A1:2020 + A2:2021 + AC:2022	1446-1	Idvorski laboratorije	21.03.2024.

Ostala tehnička dokumentacija		Oznaka:	Datum:
1.	Deklaracija o usaglašenosti	37/24	07.10.2024.
2.	Instrukcije za uključivanje uređaja	Uputstvo za rukovanje_PRK-1UM PDF file modified on 02/10/2024 at 14:25:28	
3.	Tehnički podaci o komponentama	Tehnički podaci o komponentama_PRK-1UM PDF file modified on 02/10/2024 at 14:25:15	
4.	Spisak sastavnih delova	Spisak sastavnih delova_PRK-1UM PDF file modified on 02/10/2024 at 14:25:28	
5.	Electrical scheme of a modified device	Montazna sema_5v_PRK-1UM (.jpg file)	
6.	Sertifikat ISO 9001:2015	Intercert USA, IC-QM-2010073	16.10.2020.

**Prilozi**

- Nema.

**Napomene:**

Sertifikat važi samo za uređaj sa:

- postavljena 4 feritna jezgra unutra uređaja (pozicije prikazane u Izveštaju o EMC ispitivanju broj 1446-1): CF-65SN (2 komada, po 3 namotaja), CF-50R (2 komada, po 1 i 2 namotaja).
- jedno feritno jezgro CF-65SN (2 namotaja) postavljeno na USB DC kabl za napajanje dužine 95 cm, na oko 3 cm od USB konektora na uređaju  
Proizvođač ferita: Crown Ferrite Enterprise Co., Taipei, Taiwan
- Eksterni AC/DC adapter ili Power bank nisu sastavni deo niti pribor koji se isporučuje uz ovaj uređaj i nisu predmet sertifikacije.

Pregledom tipa opreme, tj. pregledom tehničke dokumentacije dostavljene od strane podnosioca, izdaje se:

### ZAKLJUČAK

Obimom pregleda obuhvaćeni su svi aspekti bitnih zahteva i relevantnih elektromagnetnih pojava. Aparat ZADOVOLJAVA SVE BITNE ZAHTEVE iz Priloga 1 Pravilnika o elektromagnetskoj kompatibilnosti (Službeni glasnik RS br. 25/2016 i 21/2020):

- elektromagnetske smetnje koje prouzrokuje oprema ne prelaze nivo iznad kog radio i telekomunikaciona oprema ili druga oprema ne može da radi kako je predviđeno;
- nivo imunosti opreme na elektromagnetske smetnje koje se očekuju pri upotrebi opreme su u skladu sa njenom predviđanom namenom, koji toj opremi omogućava da radi bez neprihvatljivog pogoršanja njenih radnih karakteristika za predviđenu namenu.

#### Uslovi važenja sertifikata:

- Sertifikat važi samo uz sve priloge.
- Zabranjeno je kopiranje i umnožavanje, osim u celosti.
- Sertifikat ne važi ukoliko su na proizvodu sprovedene izmene. Izmene se moraju prijaviti Idvorski laboratorijama radi provere usaglašenosti sa tipom i izdavanja dopune/izmene/novog sertifikata po potrebi.
- Proizvođač je odgovoran za usaglašenost prema svim propisima primenljivim na proizvod.
- Usaglašenost svakog komada opreme/aparata/proizvoda sa tipom je obaveza i odgovornost proizvođača koji preduzima mere interne kontrole proizvodnje.
- Podnosilac zahteva snosi odgovornost za autentičnost dostavljene tehničke dokumentacije i u obavezi je da istu i Sertifikat čuva 10 godina od dana proizvodnje poslednjeg uređaja.

Mesto izdavanja:

Beograd



Direktor:

Saša Jorgovanović, dipl.el.inž.





# Relazione aggiuntiva di “Idvorski Laboratorije” sul test del dispositivo PRK-1UM con un laser di classe 1

IDVORSKY LABORATORIES Ltd. Belgrade  
Volgina 15, 11060 Belgrade, Serbia

[www.idvorsky.com](http://www.idvorsky.com)  
[office@idvorsky.com](mailto:office@idvorsky.com)  
Phone: +381 11 6776329

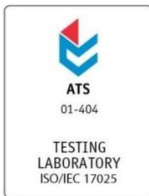

<b>EMC TEST REPORT #</b>	<b>1446-3</b>	 
Date of issue	18.07.2024.	
Date of testing	12. and 15.07.2024.	
Job #	1446	
Customer	Grigorii Grabovoi PR KONSALTING TECHNOLOGIES OF ETERNAL DEVELOPMENT, Kneza Mihaila 21A lok 113 TC Milenijum, 11102 Beograd, Srbija	
Manufacturer	Grigorii Grabovoi PR KONSALTING TECHNOLOGIES OF ETERNAL DEVELOPMENT, Kneza Mihaila 21A lok 113 TC Milenijum, 11102 Beograd, Srbija	
Product/EUT	The device of development of concentrations of eternal life PRK-1UM is of three-modes	
Model	<b>PRK-1UM three-modes</b>	
Serial No.	P189489D82.2M1	
<b>VERDICT</b> (based solely on tests listed in Clause 1)	<b>PASS</b>	
Remarks:	None.	

Tested by:

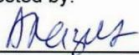
  
LAB engineer, Andrijana Lazić

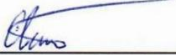
  
LAB technician, Slaven Pavlekić

  
LAB apprentice Miloš Maksimović

Verified by:

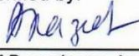
  
LAB engineer, Andrijana Lazić

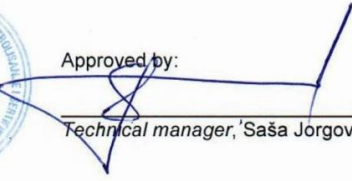

Approved by:

  
Technical manager, Saša Jorgovanović

**Disclaimer:**

This testing and results apply only for tested sample of the product (EUT). Laboratory is not responsible for the data submitted by the customer. Laboratory accepts no responsibility either misuses or wrong interpretations and decisions based on this report.

This report is not valid unless signed/authorized and shall not be reproduced except in full  
EMC Test Report #1446-3

form IL.TR.EMC2/1  
Page 1 of 19

## 1. TEST SUMMARY

The EUT is tested as tabletop equipment.

This is a **partial** test report.

The EUT was previously tested according to **EN IEC 61000-3-2:2019 + A1:2021, EN 61000-3-3:2013 + A1:2019 + A2:2021 + AC:2022-01, EN IEC 55014-1:2021 and EN IEC 55014-2:2021** and the test report #1446-2 was issued on 24.05.2024. by Idvorsky Laboratories.

The EUT was **partially** tested according to **EN IEC 55014-1:2021** in order to confirm compliance with the standard due to following changes:

- o New LED laser.

The EUT contains the following ports:

- enclosure port
- DC mains port – USB, 5 V DC.

Only tests concerning these ports shall be taken into account following the customer's request:

- enclosure port
- AC mains port of the auxiliary equipment.

**Overview of the test results** according to the test plan and specified performance criteria listed in Clause 3.5 and in EUT's mode of operation as noted in Clause 3.4 of this report:

STANDARD	TEST METHOD	PORT	MODE OF OPERATION	TEST SPECIFICATIONS	VERDICT
EN IEC 55014-1: 2021	Conducted RF emission test	AC mains port of the auxiliary equipment	The fourth and the fifth mode	Frequency range: 150 kHz – 30 MHz Measurement by application of LISN. Limits: Table 5, Clause 4.3.3.6 of EN IEC 55014-1: 2021	PASS
EN IEC 55014-1: 2021	Radiated RF emission test Applied <sup>(1)</sup> EN 55016-2-3:2017 + A1:2019	Enclosure	The fourth and the fifth mode	Frequency range: 30 MHz – 1GHz <sup>(2)</sup> Limits: Table 9, Clause 4.3.4.5 of EN IEC 55014-1:2021 Performed in SAC with BiLog antenna at 3 m distance.	PASS

(1) In cases where, in regard to the year of publication, the test method referenced by the applied product standard does not coincide with the laboratory's scope of accreditation (SoA), the test method within the SoA shall be applied as noted. In all such cases, the test methods were compared and no significant differences consing to the testing had been found.

(2) The highest internal frequency of the EUT is 16 MHz, according to the customer. The test was performed up to 1 GHz in accordance with clause 4.3.5.1 and table 10 of standard EN IEC 55014-1:2021.

## 2. CONTENTS

- 0. Front page
- 1. Test summary
- 2. Contents
- 3. Identification of the EUT
  - 3.1. Data
  - 3.2. Photographs/schematics
  - 3.3. Auxiliary equipment
  - 3.4. Modes of operation
  - 3.5. Performance criteria
  - 3.6. Product related notes
- 4. Testing location and conditions
- 5. Test results
  - 5.1. Conducted RF emission test
  - 5.2. Radiated RF emission test
- 6. Measurement equipment
- 7. Measurement uncertainty
- 8. General remarks
- 9. Appendixes

### 3. IDENTIFICATION of the EUT

#### 3.1. Data\*

**EUT:** PRK-1UM three-modes  
**Model:** PRK-1UM three-modes  
**Serial number:** P189489D82.2M1

**Nominal voltage:** 5 V DC  
**Nominal current:** 0.4 A  
**Dimensions:** 200 mm x 160 mm x 65 mm  
**Mass:** 1 kg

**USB power supply cable:** 95 cm length, with the ferrite choke CF-65SN (2 turns) at 3 cm distance from EUT's connector

**Note:** EUT is not a medical device, according to the customer.

\*Supplied by the customer

#### 3.2. Photographs/schematics



EUT, top side



EUT, bottom side



EUT, front side



EUT, rear side



EUT, left side



EUT, right side



EUT, USB power supply cable (95 cm length)



The new laser label

### 3.3. Auxiliary equipment

MARK	NAME / TYPE / PURPOSE	QUANTITY
Turnmax power supply	AC/DC adapter for power supply of the EUT	1

Photographs:



AC/DC power supply adapter 5 V DC

### 3.4. Modes of operation

MODE OF OPERATION	DESCRIPTION
<b>The fourth mode</b>	The EUT is powered via USB cable of 95 cm connected to 5 V DC AC/DC adapter which is connected to 230 V, 50 Hz distribution network. Button 1 and 2 are off. The fourth mode is activated by turning on the button 3 which lights up blue when is turned on. This mode includes two lasers and an OLED screen. The inclusion of the laser can be observed from the back of the device through the ventilation holes. The required series of numbers is written to the SD card. An OLED display is used to read the numeric series. For this additional function, It is necessary to turn off the button on the left side of the OLED screen, insert the SD card and turn on the button on the left side of the OLED screen. Inscriptions appear on the display. SD card is inserted into a special slot on the front panel on the right side.
<b>The fifth mode</b>	The EUT is powered via USB cable of 95 cm connected to 5 V DC AC/DC adapter which is connected to 230 V, 50 Hz distribution network. Button 1 and 2 are off. Button 3 is turned on and lights up blue. This mode includes two lasers and an OLED screen. The inclusion of the laser can be observed from the back of the device through the ventilation holes. The required series of numbers is written to the SD card. An OLED display is used to read the numeric series. For this additional function, It is necessary to turn off the button on the left side of the OLED screen, insert the SD card and turn on the button on the left side of the OLED screen. Inscriptions appear on the display. SD card is inserted into a special slot on the front panel on the right side. The fifth mode is activated by pressing the metal button on the right side of the screen. The LED on the front panel above the SD card is flashing.

The manufacturer's remark: Mode 4<sup>th</sup> refers to the additional functions of modes 1 and 2.





OLED display showing the numeric series

### 3.5. Performance criteria

#### 3.5.1. Emission criteria

Conducted RF emission 150 kHz – 30 MHz: Required emission limits are according to the customer's request and also in accordance with table 5, Clause 4.3.3.6 of EN IEC 55014-1:2021.

Radiated RF emission 30 MHz – 1 GHz: Required emission limits are according to the customer's request and also in accordance with the limits from table 9, Clause 4.3.4.5 of EN IEC 55014-1:2021.

#### 3.5.2. Immunity criteria

None.

### 3.6. Product related notes

Data of the new laser, provided by the customer:



#### Dot laser, red, 650 nm, 0.4 mW

LFD650-0.4-12(9x20)  
 Order Number: 70108507

Main Parameters (*)	min	typ	max	Unit
Wavelength		650		nm
Optical Diode Power	0.2	0.4	0.4	mW
Operating Voltage	3	3	12	V DC
Operating Current	5	15	25	mA
Operating Temperature	-20		40	°C
Storage Temperature	-40		80	°C

#### Main Data

Warranty 1 years

#### Technical Parameters

Lifetime > 3,000 h  
 RoHS yes

#### Optical Parameters

Beam Shape	Dot
Laser Class	1
Divergence	H - 1.0 mrad
Beam Diameter	3 mm
Size of Laserdot	<4.5mm@5m
Operating Distance	10 m
Optics	acryl lens
Laser technology	diode
Focus	collimated

#### Electrical Parameters

Power Supply LFNT-3

#### Mechanical Parameters

Size	Ø9x20 mm
Material	Brass
Cable length	100 mm
Wire type	28AWG, 0,14mm <sup>2</sup>
Output Aperture	3 mm
Weight	6 g

(\*) Over the complete operating temperature range

#### Features

- Compact size

- Laser Class 1
- Low power consumption
- Operating Voltage 3-12V DC
- Low cost

#### Picture



#### Cable color

Ground		black	GND
Positive		red	3 - 12, typ 3 V DC

#### Drawing

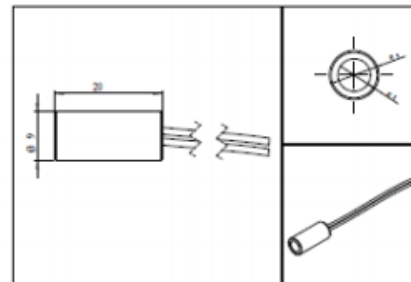

#### Safety Label



#### Valid Revision

13 | 06-MAY-2022

## 4. TESTING LOCATION AND CONDITIONS

Location: **Idvorsky Laboratories Ltd. Belgrade**  
 Volgina 15, 11060 Belgrade, Serbia

Conditions:

Temperature: 25.7 °C – 27.3 °C  
 Relative humidity: 50.1 % – 56.3 %  
 Atmospheric pressure: 987 hPa – 989 hPa

## 5. TEST RESULTS

### 5.1. Conducted RF emission test

Date: 12.07.2024.  
Test standard: EN IEC 55014-1:2021  
Tested by: Andrijana Lazić, Slaven Pavlekić and Miloš Maksimović

#### 5.1.1. Setup

##### 5.1.1.1. The fourth mode

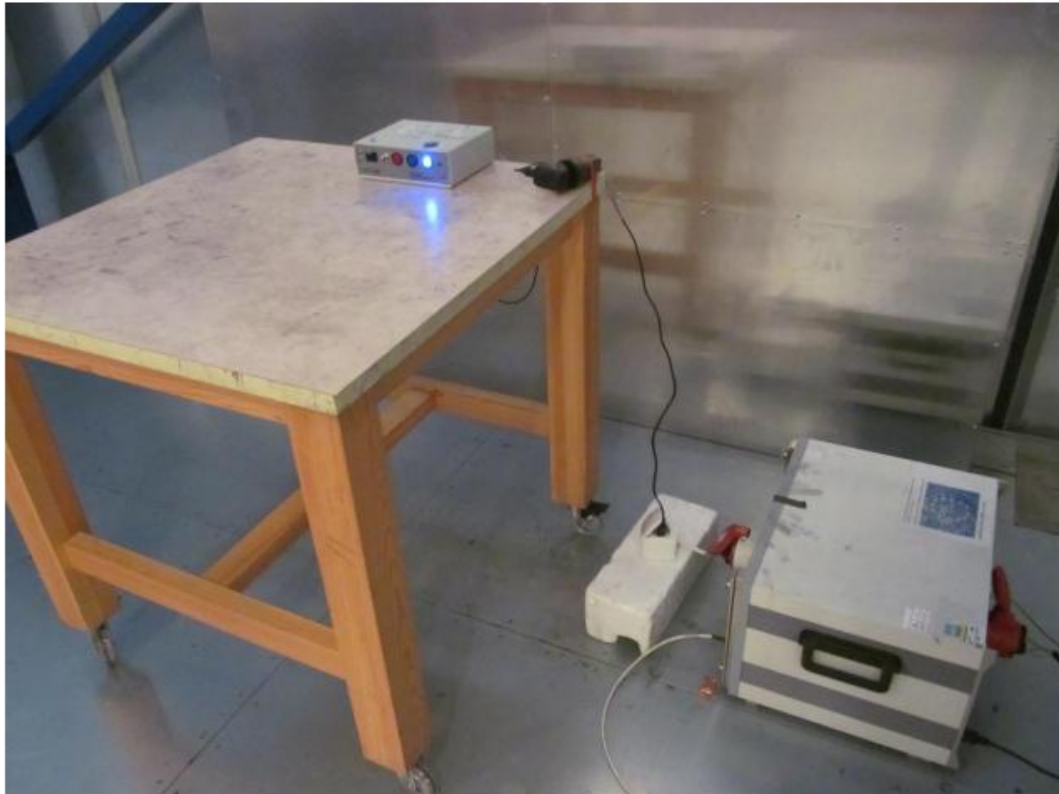

Port under test: AC mains port of the auxiliary equipment (LISN)  
AC mains port voltage: 219 V, 50 Hz ( $I_{max} = 10$  mA)  
Frequency range: 150 kHz – 30 MHz  
Pre-scan dwell time: 10 ms  
Pre-scan detector: Peak  
Step: 4 kHz  
Final measurement time: 15 s  
Mode of operation: The fourth mode

#### 5.1.1.2. The fifth mode

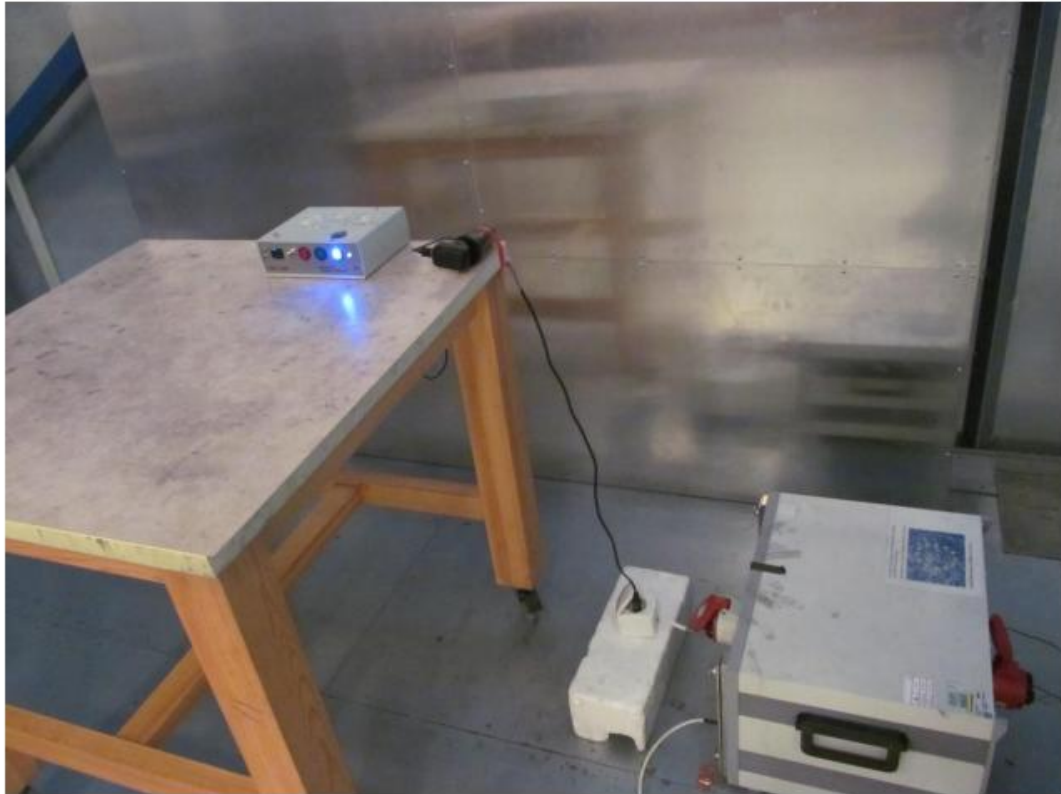

Port under test:	AC mains port of the auxiliary equipment (LISN)
AC mains port voltage:	219 V, 50 Hz ( $I_{max} = 10 \text{ mA}$ )
Frequency range:	150 kHz – 30 MHz
Pre-scan dwell time:	10 ms
Pre-scan detector:	Peak
Step:	4 kHz
Final measurement time:	15 s
Mode of operation:	The fifth mode

## 5.1.2. Results

### 5.1.2.1. The fourth mode

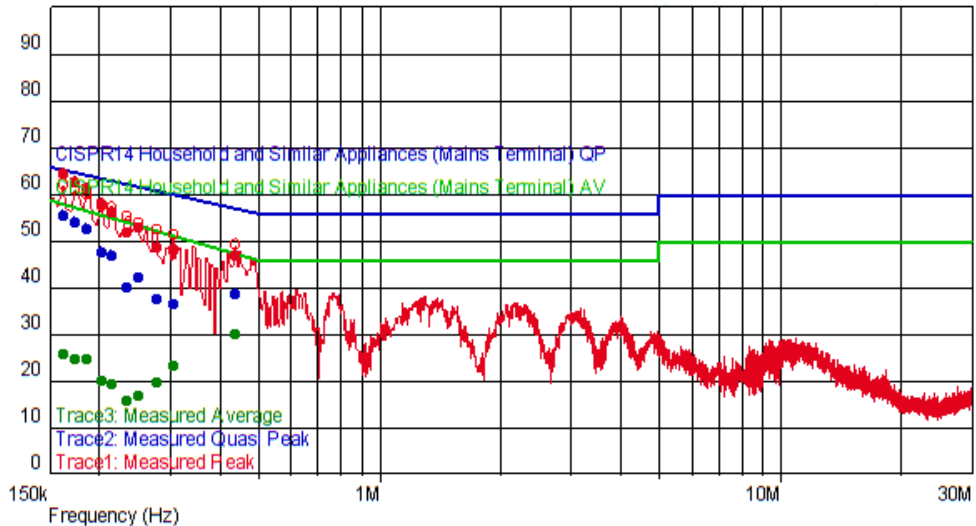

List of selected disturbances:

f [MHz]	Pk level [dBuV]	QP level [dBuV]	QP limit [dBuV]	QP margin [dB]	Av level [dBuV]	Av limit [dBuV]	Av margin [dB]	LINE
0.162	64.096	55.270	65.361	-10.090	25.856	58.169	-32.313	N
0.174	62.285	54.010	64.767	-10.760	24.905	57.397	-32.492	N
0.186	60.908	52.470	64.213	-11.750	24.618	56.677	-32.059	N
0.202	57.927	47.370	63.528	-16.160	20.227	55.786	-35.559	N
0.214	56.196	46.950	63.049	-16.100	19.436	55.163	-35.727	N
0.234	51.737	40.190	62.307	-22.120	15.987	54.198	-38.212	N
0.250	52.867	42.100	61.757	-19.660	16.777	53.484	-36.707	N
0.278	48.657	37.540	60.875	-23.340	19.607	52.338	-32.731	N
0.306	48.214	36.470	60.078	-23.600	23.474	51.302	-27.828	N
0.438	46.873	38.650	57.100	-18.450	30.193	47.429	-17.236	N

Limits: Clause 4.3.3.6, table 5 of EN IEC 55014-1:2021.

Verdict: **PASS**

5.1.2.2. The fifth mode

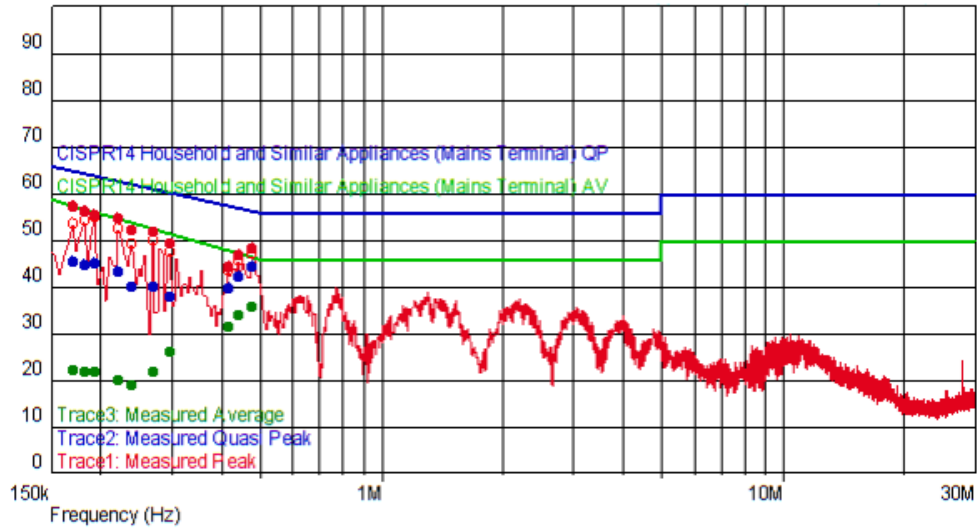

List of selected disturbances:

f [MHz]	Pk level [dBuV]	QP level [dBuV]	QP limit [dBuV]	QP margin [dB]	Av level [dBuV]	Av limit [dBuV]	Av margin [dB]	LINE
0.170	57.041	45.490	64.960	-19.470	22.301	57.649	-35.348	L1
0.182	56.218	44.800	64.394	-19.600	21.938	56.912	-34.975	L1
0.194	55.485	44.910	63.864	-18.950	21.975	56.223	-34.248	L1
0.222	54.694	43.120	62.744	-19.620	20.174	54.767	-34.593	L1
0.238	52.028	40.210	62.166	-21.960	19.158	54.015	-34.858	L1
0.270	51.751	40.180	61.118	-20.940	21.891	52.653	-30.762	L1
0.298	49.208	37.940	60.298	-22.360	26.118	51.588	-25.469	L1
0.418	44.385	39.690	57.488	-17.800	31.665	47.934	-16.269	L1
0.442	46.943	42.230	57.024	-14.790	33.963	47.331	-13.368	L1
0.478	48.369	44.180	56.374	-12.190	35.769	46.486	-10.717	L1

Limits: Clause 4.3.3.6, table 5 of EN IEC 55014-1:2021.

Verdict: **PASS**

5.1.3. Deviations

None.

5.1.4. Comments

None.

## 5.2. Radiated RF emission test

Date: 12. and 15.07.2024.  
Test standard: EN 55016-2-3:2017 + A1:2019  
Tested by: Andrijana Lazić, Slaven Pavlekić and Miloš Maksimović

### 5.2.1. Setup

Note: Pre-scan measurements were made in different modes of operation of the EUT in order to determine the worst case regarding radiated RF emission.

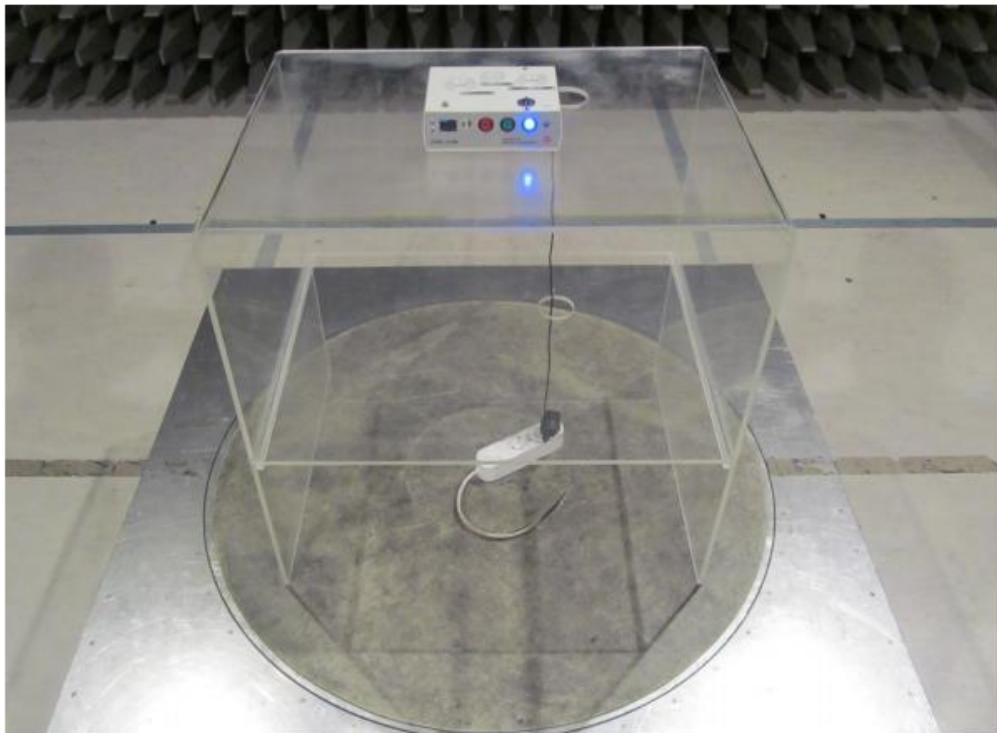

Test location:	semi-anechoic chamber
EUT to antenna distance:	3 m
Pre-scan RBW:	120 kHz (step 40 kHz)
Pre-scan dwell time:	2 ms
Final measurement:	15 s
Final RBW:	120 kHz
Mode of operation:	The fourth mode ( $U = 223 \text{ V}$ , $I_{\text{max}} = 10 \text{ mA}$ )



Test location: semi-anechoic chamber  
 EUT to antenna distance: 3 m  
 Pre-scan RBW: 120 kHz (step 40 kHz)  
 Pre-scan dwell time: 2 ms  
 Final measurement: 15 s  
 Final RBW: 120 kHz  
 Mode of operation: The fifth mode ( $U = 223 \text{ V}$ ,  $I_{\max} = 10 \text{ mA}$ )

Pre-scan, both modes of operation, deciding the worst case:

Pre-scan angles:  $0^\circ$ ,  $90^\circ$ ,  $180^\circ$  and  $270^\circ$   
 Pre-scan antenna height: 1 m  
 Pre-scan antenna polarization: HOR and VER

Pre-scan, the worst case, complete test

Pre-scan angles:  $0^\circ$ ,  $90^\circ$ ,  $180^\circ$  and  $270^\circ$   
 Pre-scan antenna height: 1 m, 2.5 m and 4 m  
 Pre-scan antenna polarization: HOR and VER  
 Mode of operation: The fifth mode ( $U = 223 \text{ V}$ ,  $I_{\max} = 10 \text{ mA}$ )

Limits:

Frequency range [MHz]	Average limit dB( $\mu\text{V}/\text{m}$ )	Quasi-peak limit dB( $\mu\text{V}/\text{m}$ )	Peak limit dB( $\mu\text{V}/\text{m}$ )
30 – 230	--	40	--
230 – 1000	--	47	--



## 5.2.2. Results

### 5.2.2.1. Pre-scan, both modes of operation, deciding the worst case

#### The fourth mode

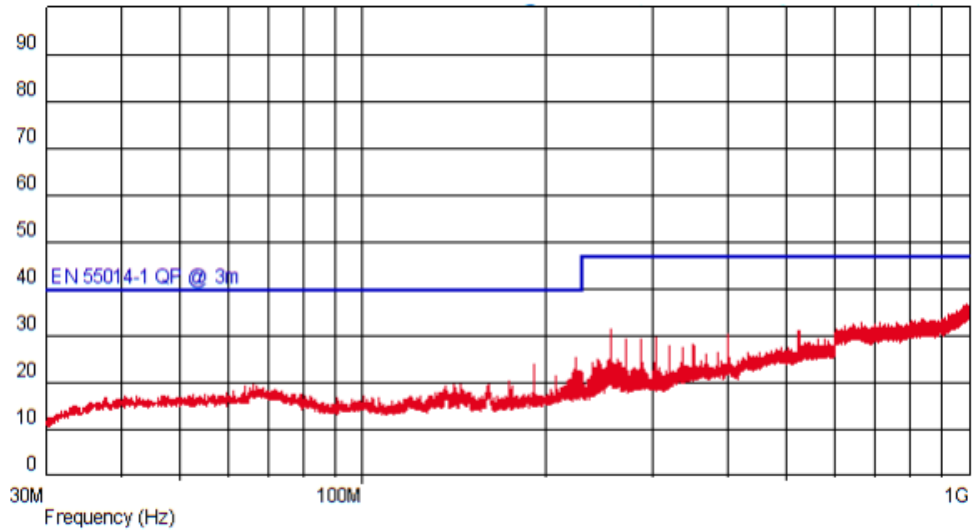

**Note:** Pre-scan measurement was made in order to determine the worst case regarding radiated RF emission.

#### The fifth mode

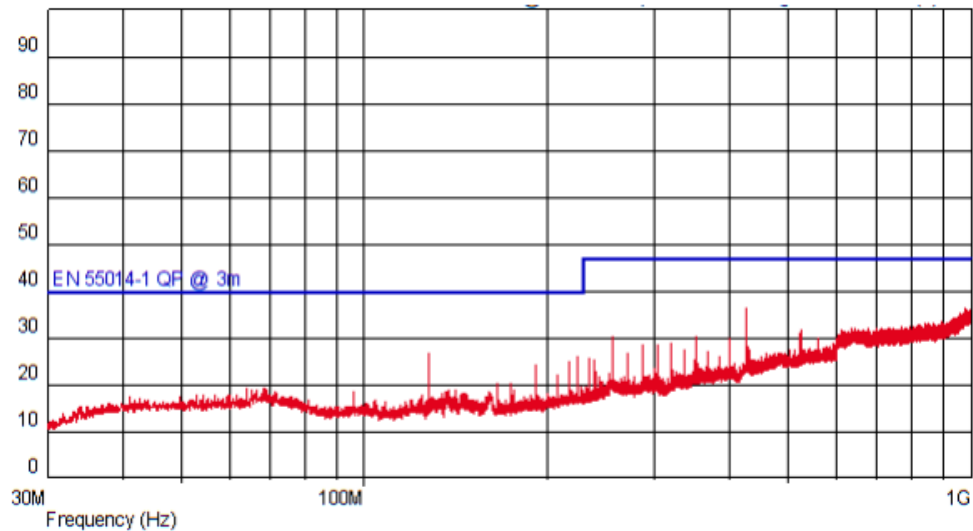

**Note:** Pre-scan measurement was made in order to determine the worst case regarding radiated RF emission.

### 5.2.2.2. Complete test, the fifth mode

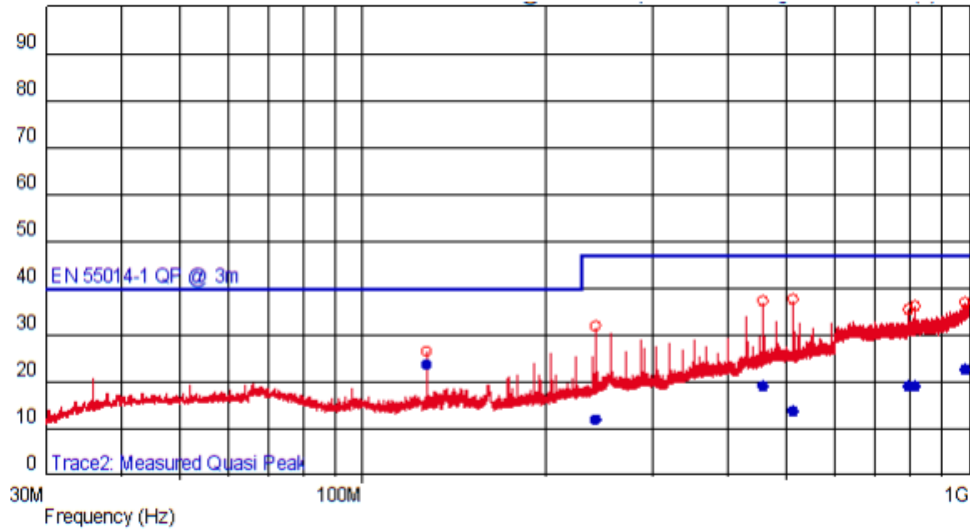

List of selected disturbances:

Frequency [MHz]	QP level [dBuV/m]	QP limit [dBuV/m]	Margin [dB]	Antenna polarization	Azimuth [deg]	Antenna height [m]
127.999	23.770	40	-16.230		85	1.030
241.960	12.010	47	-34.990	--	165	1.030
457.200	18.900	47	-28.100		2	1.820
513.601	13.520	47	-33.480	--	239	4.000
794.639	18.870	47	-28.130	--	360	3.990
814.520	19.190	47	-27.810		252	1.250
984.199	22.720	47	-24.280		66	1.250

Limits: Clause 4.3.4.5, table 9 of EN IEC 55014-1:2021

Verdict: **PASS**

### 5.2.3. Deviations

None.

### 5.2.4. Comments

The highest internal frequency of the EUT is 16 MHz, according to the customer. The test was performed up to 1 GHz in accordance with clause 4.3.5.1 and table 10 of standard EN IEC 55014-1:2021.

## 6. MEASUREMENT EQUIPMENT

The following equipment is used for tests:

Type	Manufacturer	Model	Ser.No.	IN number	USED IN TEST-S Reported in the Clause/s:
EMI receiver	Schaffner	SMR4503	81	0138	5.1. 5.2
Software	Teseq	Compliance 5 E/I v5.26.4	517-2881623-74 and 517-2846725-70	0125	5.1. 5.2
V-network 4-line	Teseq	NNB52	27384	0134	5.1
Antenna	Teseq	CBL6144	35349	0115	5.2
Semi anechoic chamber	Comtest	3m	/	0305	5.2
Antenna mast	Maturo	CAM-4.0	/	306	5.2
Controller	Maturo	MSU	/	307	5.2
Pulse limiter	Schwarzbeck	VTSD 9561-F	9561-F-N 0971	0356	5.1

## 7. MEASUREMENT UNCERTAINTY

For test 5.1: AC mains port:  $U_{LAB} = U_{CISPR} = 3.4$  dB in frequency range 150 kHz – 30 MHz.  
Expanded uncertainty of measurement, expressed as the standard uncertainty of measurement multiplied by the coverage factor  $k = 2$ , which for normal distribution corresponds to a coverage probability of approximately 95 %. Measurement uncertainty calculation is carried out according to EN 55016-4-2:2011 + A1:2014 + A2:2018.

For test 5.2: 4.9 dB (HOR 30 MHz – 300 MHz)  
5 dB (VER 30 MHz – 300 MHz)  
5.2 dB (HOR and VER 300 MHz – 1000 MHz)  
Expanded uncertainty of measurement expressed as the standard uncertainty of measurement multiplied by the coverage factor  $k = 2$ , which for normal distribution corresponds to a coverage probability of approximately 95 %.  
Measurement uncertainty is according to EN 55016-4-2:2011 + A1:2014 + A2:2018 ( $U_{LAB} \leq U_{CISPR}$ ).

## 8. GENERAL REMARKS

Date format is dd.mm.yyyy.

Decimal mark is indicated by dot (.) within the report.

## 9. APPENDIXES

None.

END OF THE REPORT



